

SURGICAL CATALOG

Surgical instruments have been
manufactured since the dawn of prehistory



Scissors	PAGE NO 5 TO 26
Delicate Scissors	PAGE NO 27 TO 31
Durotip TC Scissors	PAGE NO 32 TO 44
Super Cut Scissors	PAGE NO 45 TO 51
Noir Supreme Cut Scissors	PAGE NO 52 TO 55
Needle Holders	PAGE NO 56 TO 61
Durotip TC Needle Holders	PAGE NO 62 TO 78
Ligature Needles	PAGE NO 79 TO 80
Dressing & Tissue Forceps	PAGE NO 81 TO 101
Durotip Tissue Forceps	PAGE NO 102 TO 105
Abdominal & Intestinal Grasping Forceps	PAGE NO 106 TO 127
Atraumatic Intestinal Forceps & Clamps	PAGE NO 128 TO 133
Atraumatic Intestinal & Dressing & Sponge Forceps	PAGE NO 135
Dressing & Sponge Forceps	PAGE NO 135 TO 139
Tongue Forceps	PAGE NO 140 TO 141
Biospy Forceps	PAGE NO 142
Hemostatic Forceps & Clamps	PAGE NO 143 TO 161

Dissecting & Right Angle Forceps	PAGE NO 162 TO 173
Towel Tubing Clamps	PAGE NO 174 TO 177
Skin Hooks	PAGE NO 178 TO 179
Hook Retractors	PAGE NO 180
Hand Held Retractors	PAGE NO 181 TO 208
Abdominal Retractors	PAGE NO 209 TO 237
Universal Ring Retractors System	PAGE NO 238 TO 239
Self Retaning Retractors	PAGE NO 240 TO 247
Rectual Specula Instruments	PAGE NO 248 TO 251
Probes & Dilators & Scoops	PAGE NO 252 TO 258
Scalpel Handle	PAGE NO 259 TO 262
Amputation & Autopsy Instruments	PAGE NO 263 TO 265
Suction Tubes	PAGE NO 266 TO 269
Accessories	PAGE NO 270 TO 271
Tongue Forceps	PAGE NO 140 TO 141
Biospy Forceps	PAGE NO 142
Hemostatic Forceps & Clamps	PAGE NO 143 TO 161

Types of Stainless Steel

304

Grade 304 is the most widely used stainless steel with good resistance to atmospheric corrosion. This grade has excellent workability, weldability and impact strength. It is sometimes known as 18/8 stainless steel, since it contains 18% chromium and 8% nickel. It is suitable for use in a variety of instruments, in fact it is the most common stainless steel, and about 60% of all stainless steel used in the world is grade 304.

302

Grade 302 is an austenitic chromium-nickel stainless steel. Type 302 is a higher carbon, earlier version of Type 304 stainless steel, and many 302 applications have switched to Type 304 with the improvements in melting technology. Type 302 is non-magnetic.

316L

Grade 316L is an austenitic chromium-nickel steel with low carbon content. It has good corrosion resistance to most chemicals and a high creep strength at elevated temperatures. The low carbon content reduces the possibility of corrosion in medical instruments.

410

Grade 410 is the basic, general purpose martensitic stainless steel that is used for highly stressed parts and provides good corrosion resistance plus high strength and hardness. Alloy 410 contains a minimum of 11.5% chromium which is just sufficient enough to demonstrate corrosion resistance properties in mild atmospheres, steam, and many mild chemical environments. It is a general purpose grade that is often supplied in the hardened but still machineable condition for applications where high strength and moderate heat and corrosion resistance are required. Alloy 410 displays maximum corrosion resistance when it's been hardened, tempered, and then polished.

420

Grade 420 is a martensitic stainless steel that provides good corrosion resistance similar to 410 plus increased strength and hardness. It is magnetic in both the annealed and hardened conditions. Maximum corrosion resistance is attained only in the fully hardened condition.
APPLICATIONS
Surgical & Dental instruments.

440

Grade 440 stainless steels are high carbon steels, which attain the highest hardness, wear resistance and strength of all stainless steel grades after heat treatment.
Applications
Grade 440 stainless steels find applications in the following:
Chisels
Medical & Surgical equipments.

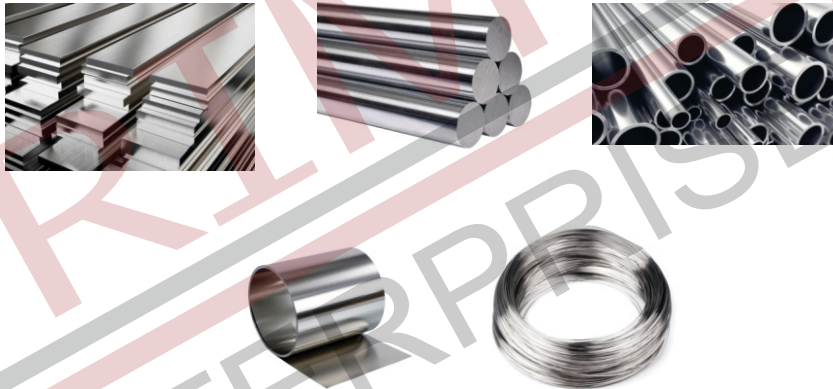

MDMS PROCESS BASED ON TRADITION,
EXPERIENCE AND STATE-OF-THE-ART TECHNOLOGY

CNC Milling Machine



CNC Lathe Machine



CNC Wire Cut EDM



DEAVER Suture Scissors

Catalog Number	Tip	Blade	Length (in.)
BC374R	S/B	STR	5 3/4
BC474R	S/B	CVD	5 3/4
BC464R	B/B	CVD	5 3/4



BC374R-BC474R

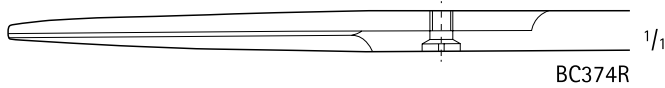

BC374R

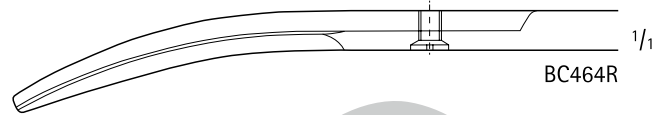

BC464R

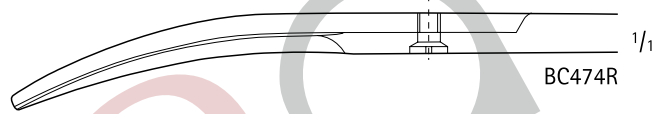

BC474R



BC130R-BC131R

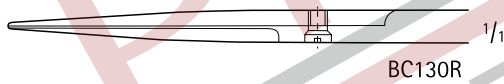

BC130R

Suture Scissors

Catalog Number	Tip	Blade	Length (in.)
BC130R	S/S	STR	4 3/4
BC341R	S/S	STR	4 1/2
BC343R	S/S	STR	5 1/8
BC344R	S/S	STR	5 3/4
BC345R	S/S	STR	6
BC346R	S/S	STR	6 1/2
BC131R	S/S	CVD	4 3/4

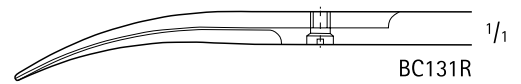

BC131R

BC341R-BC346R

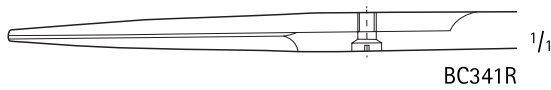

BC341R

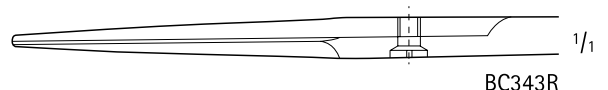

BC343R

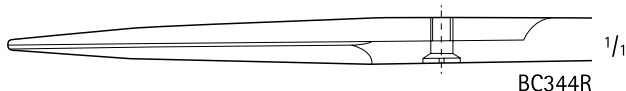

BC344R

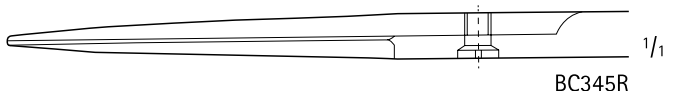

BC345R

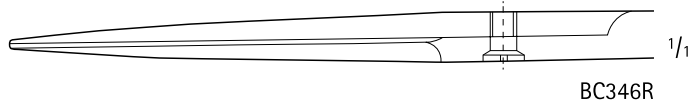

BC346R



BC441R-BC445R



BC441R

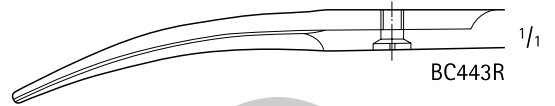

BC443R

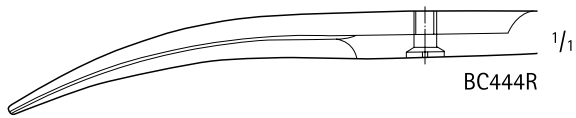

BC444R

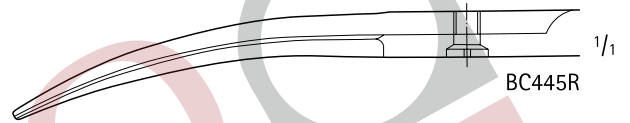

BC445R

Suture Scissors

Catalog Number	Tip	Blade	Length (in.)
BC441R	S/S	CVD	4 1/2
BC443R	S/S	CVD	5 1/8
BC444R	S/S	CVD	5 3/4
BC445R	S/S	CVD	6



BC303R-BC304R

Suture Scissors

Catalog Number	Tip	Blade	Length (in.)
BC303R	S/B	DEL, STR	5 1/8
BC304R	S/B	DEL, STR	5 3/4

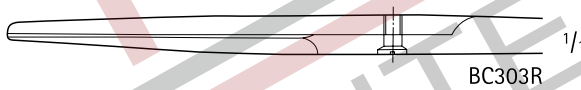

BC303R



BC304R



BC496R

Scissors

Catalog Number	Tip	Blade	Length (in.)
BC496R	S/B	STR/1-SERR	5 1/8

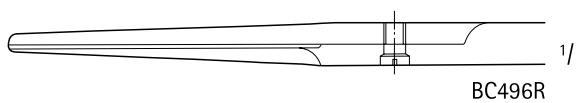

BC496R

Suture Scissors

Catalog Number	Tip	Blade	Length (in.)
BC320R	S/B	STR	4 1/8
BC321R	S/B	STR	4 1/2
BC323R	S/B	STR	5 1/8
BC324R	S/B	STR	5 3/4
BC325R	S/B	STR	6
BC326R	S/B	STR	6 1/2
BC327R	S/B	STR	6 7/8
BC328R	S/B	STR	7 1/4
BC330R	S/B	STR	7 7/8
BC403R	S/B	CVD	5 1/8
BC404R	S/B	CVD	5 3/4

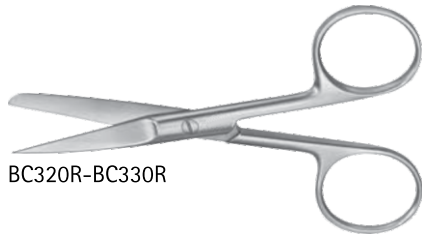

BC320R-BC330R

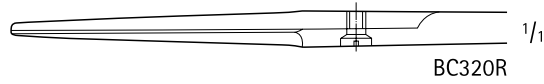

BC320R

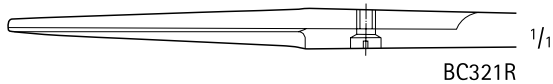

BC321R

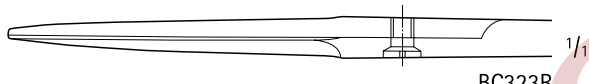

BC323R

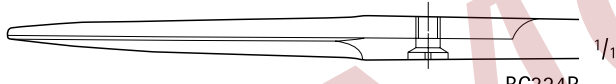

BC324R

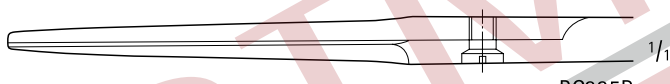

BC325R



BC326R



BC327R



BC328R



BC330R

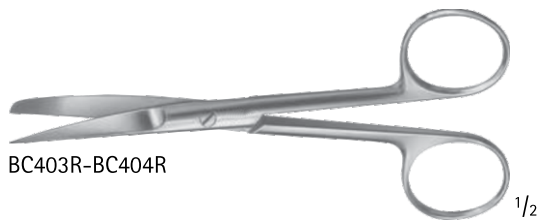

BC403R-BC404R

1/2

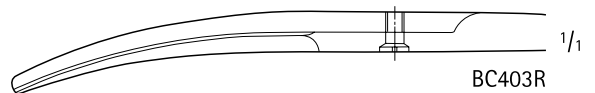

BC403R

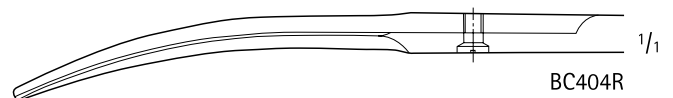

BC404R

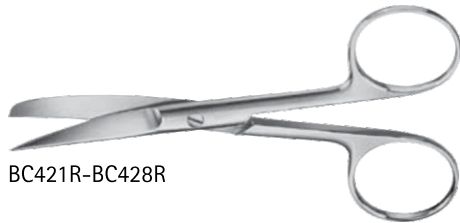

BC421R-BC428R

Suture Scissors

Catalog Number	Tip	Blade	Length (in.)
BC421R	S/B	CVD	4 1/2
BC423R	S/B	CVD	5 1/8
BC424R	S/B	CVD	5 3/4
BC425R	S/B	CVD	6
BC426R	S/B	CVD	6 1/2
BC428R	S/B	CVD	7 1/4



BC421R

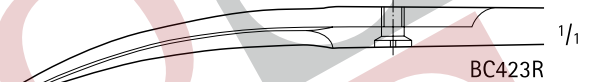

BC423R

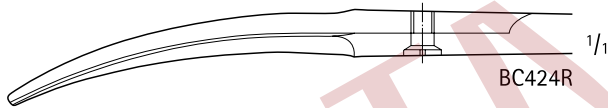

BC424R

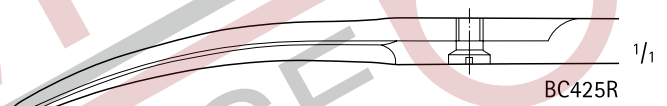

BC425R

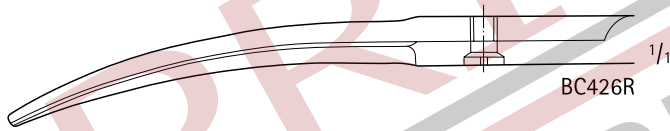

BC426R

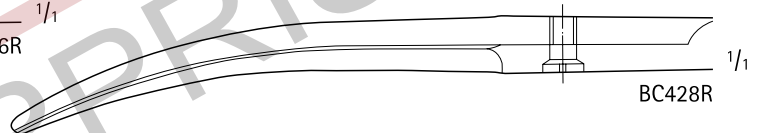

BC428R

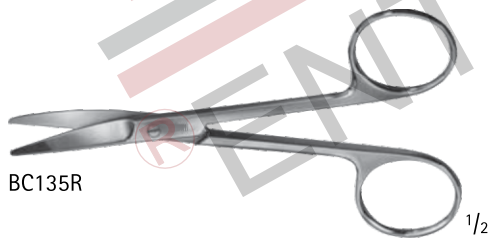

BC135R

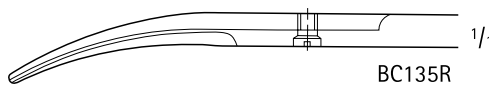

BC135R

Suture Scissors

Catalog Number	Tip	Blade	Length (in.)
BC135R	B/B	CVD, DEL	4 3/4

COOPER Suture Scissors

Catalog Number	Tip	Blade	Length (in.)
BC313R	B/B	STR	5 1/8
BC314R	B/B	STR	5 3/4
BC315R	B/B	STR	6
BC316R	B/B	STR	6 1/2
BC317R	B/B	STR	6 7/8
BC411R	B/B	CVD	4 1/2
BC413R	B/B	CVD	5 1/8
BC414R	B/B	CVD	5 3/4
BC415R	B/B	CVD	6
BC416R	B/B	CVD	6 1/2
BC417R	B/B	CVD	6 7/8

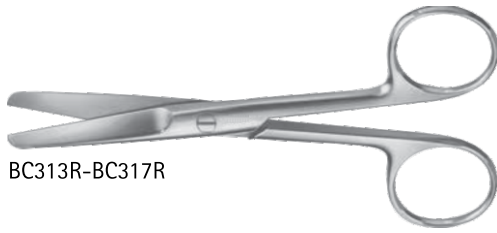

BC313R-BC317R

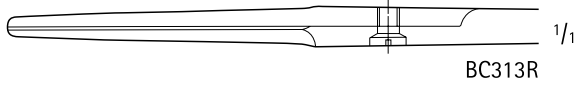

BC313R

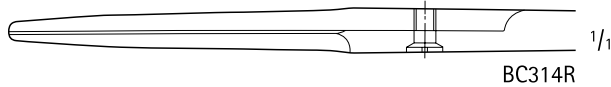

BC314R



BC315R

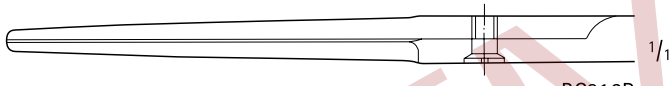

BC316R



BC317R



BC411R-BC417R

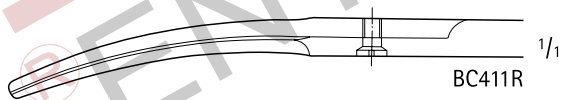

BC411R

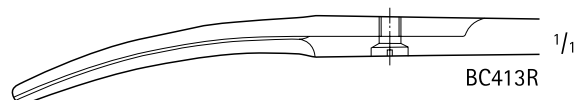

BC413R

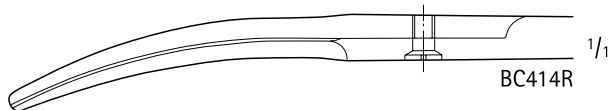

BC414R

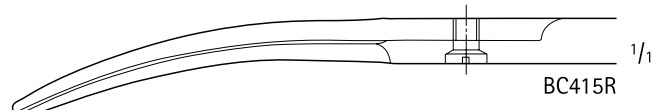

BC415R

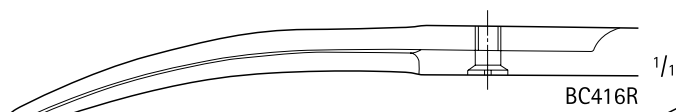

BC416R

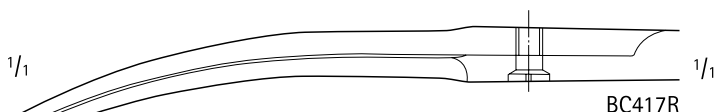

BC417R

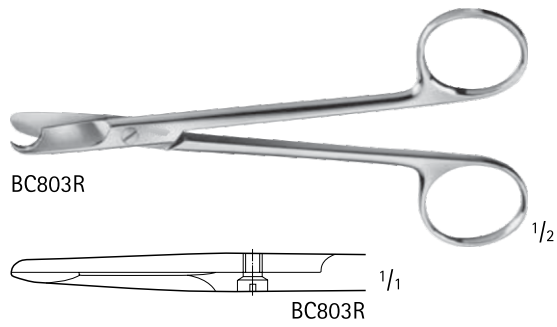

LITTAUER Ligature Scissors

Catalog Number	Tip	Blade	Length (in.)
BC803R	B/1-NOTCH	STR	5 1/4

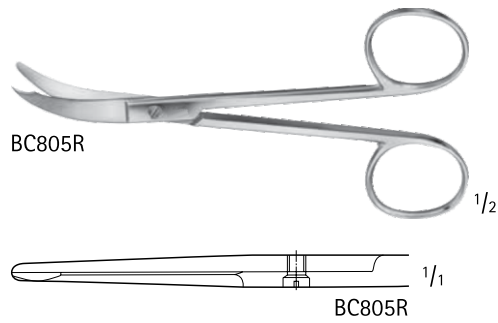

NORTHBENT Ligature Scissors

Catalog Number	Tip	Blade	Length (in.)
BC805R	B/1-NOTCH	LAT-CVD	4 3/4

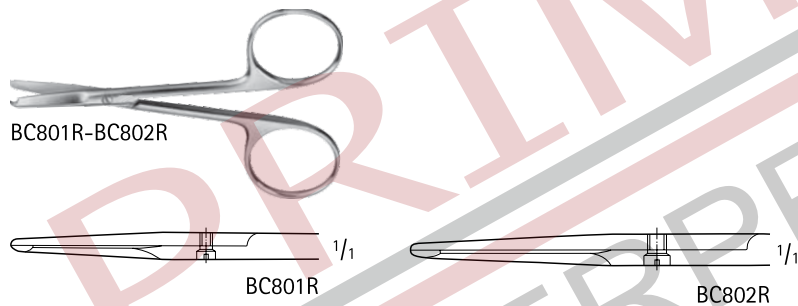

SPENCER Suture Scissors

Catalog Number	Tip	Blade	Length (in.)
BC801R	B/1-NOTCH	STR	3 1/2
BC802R	B/1-NOTCH	STR	4 1/2

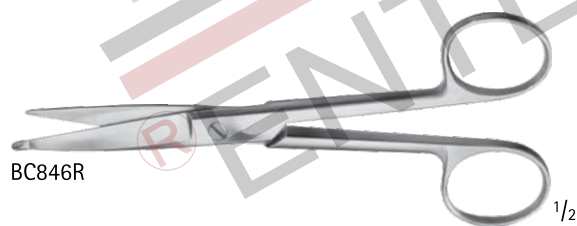

KNOWLES Bandage Scissors

Catalog Number	Tip	Blade	Length (in.)
BC846R	1-PROBE-POINT	STR	5 3/4
BC847R	1-PROBE-POINT	LAT-ANG	5 1/2

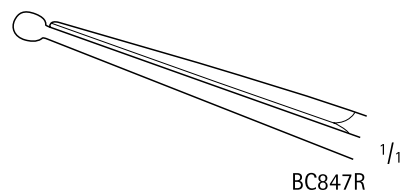
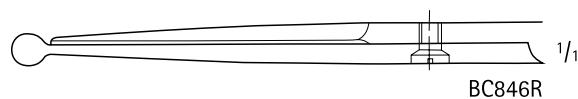



BC848R-BC863R

LISTER Bandage Scissors

Catalog Number	Blade	Length (in.)
BC848R	LONG	6 1/8
BC849R	LONG	7
BC860R	STANDARD	4 1/2
BC861R	STANDARD	5 1/2
BC862R	STANDARD	7
BC863R	STANDARD	7 7/8

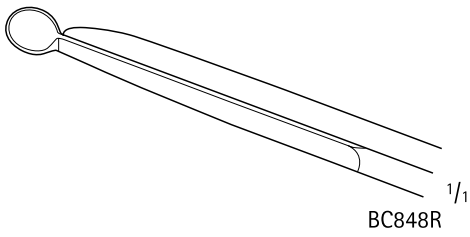

BC848R

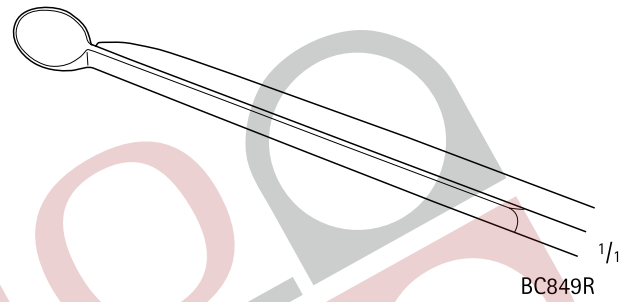

BC849R

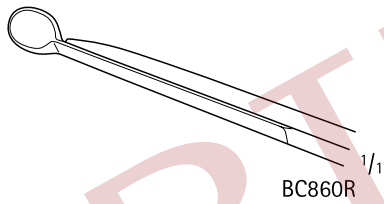

BC860R

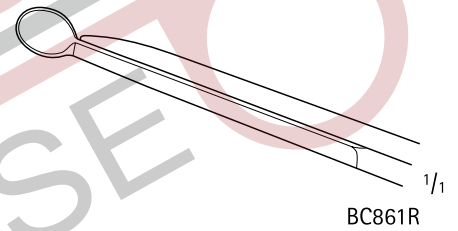

BC861R

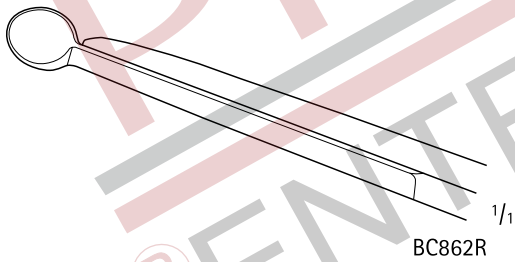

BC862R

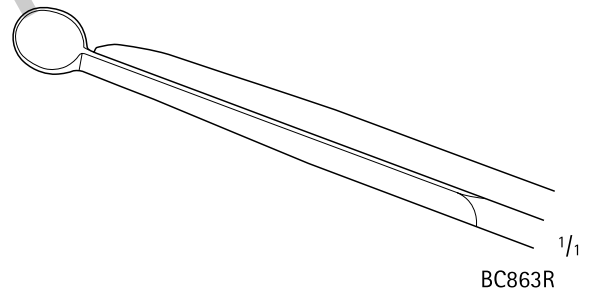

BC863R



MG379R



MG379R

LISTER Bandage Scissors, Gold Handle

Catalog Number	Length (in.)
MG379R	5 1/2



LISTER Bandage Scissors, W/ One Large Ring

Catalog Number	Length (in.)
MB223	8

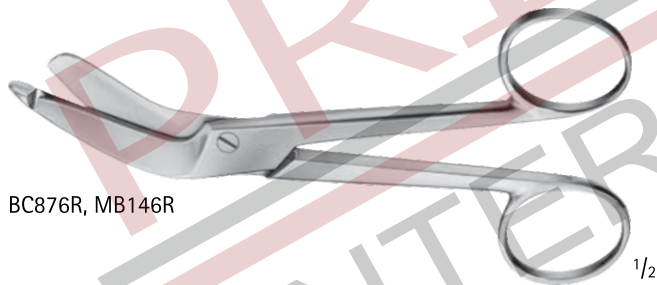

LISTER Bandage Scissors, Serrated

Catalog Number	Length (in.)
MB146R	3 1/2
BC876R	6 1/4

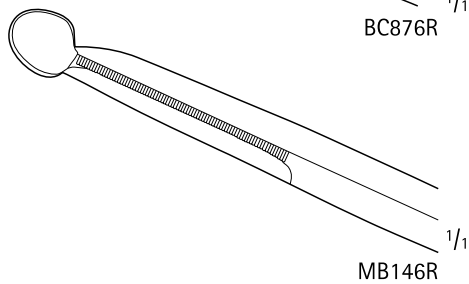
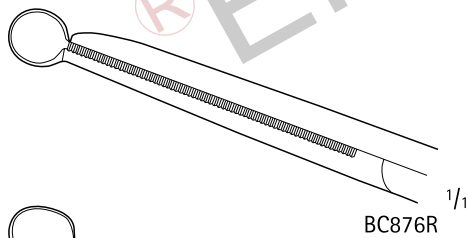



BC890R

1/2

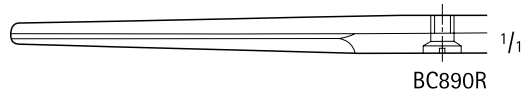

BC890R



BC885R-BC979R

1/2

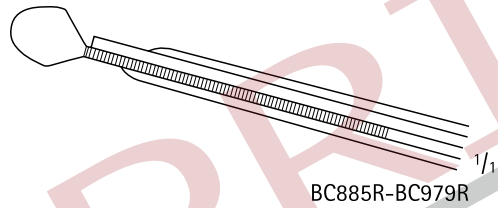

BC885R-BC979R



BC881R-BC989R

1/2

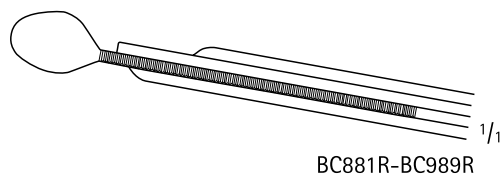

BC881R-BC989R

Nurse's Bandage Scissors

Catalog Number	Tip	Blade	Handle Color	Length (in.)
BC890R	B/B	STR	RED	5 3/4

LISTER Universal Bandage Scissors, Serrated

Catalog Number	Handle Color	Length (in.)
BC885R	BLACK	5 3/4
BC970R	RED	5 3/4
BC971R	BLUE	5 3/4
BC973R	YELLOW	5 3/4
BC975R	ORANGE	5 3/4
BC977R	PINK	5 3/4
BC978R	LIGHT GREEN	5 3/4
BC979R	VIOLET	5 3/4

Universal Bandage Scissors, W/ One Large Ring, Serrated

Catalog Number	Handle Color	Length (in.)
BC881R	BLACK	7
BC980R	RED	7
BC981R	BLUE	7
BC983R	YELLOW	7
BC985R	ORANGE	7
BC987R	PINK	7
BC988R	LIGHT GREEN	7
BC989R	VIOLET	7

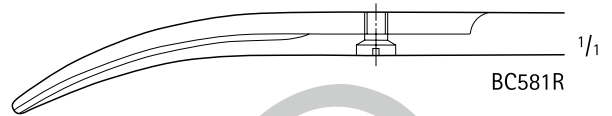
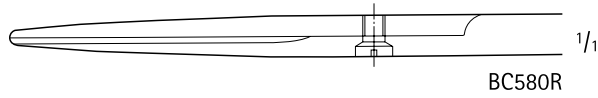

**STILLE Dissecting Scissors, Round
Blades**

Catalog Number	Tip	Blade	Length (in.)
BC580R	B/B	STR	6
BC581R	B/B	CVD	6

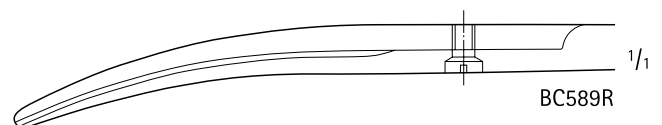
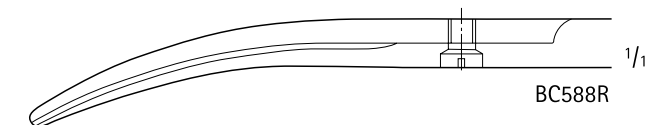
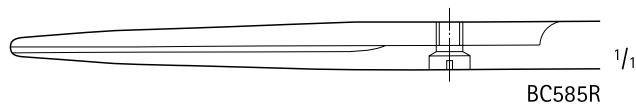
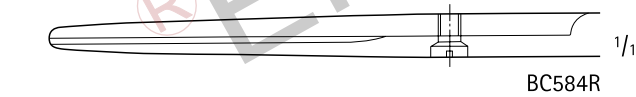

MAYO Dissecting Scissors, Round Blade

Catalog Number	Tip	Blade	Length (in.)
BC584R	B/B	STR	6 1/2
BC585R	B/B	STR	7 7/8
BC587R	B/B	CVD	6 1/2
BC588R	B/B	CVD	7 7/8
BC589R	B/B	CVD	8 1/4



BC560R-BC561R

¹/₃

**MAYO-HARRINGTON Dissecting
Scissors**

Catalog Number	Tip	Blade	Length (in.)
BC560R	B/B	STR	9
BC561R	B/B	CVD	9

¹/₁
BC560R

¹/₁
BC561R



BC567R-BC568R

¹/₃

**MAYO-HARRINGTON Dissecting
Scissors**

Catalog Number	Tip	Blade	Length (in.)
BC568R	B/B	STR	11
BC567R	B/B	CVD	11

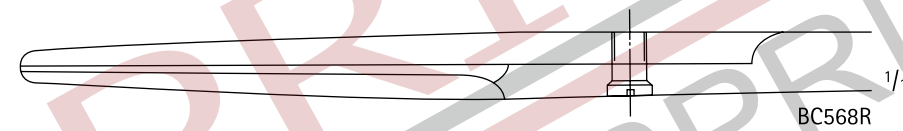

BC568R

¹/₁

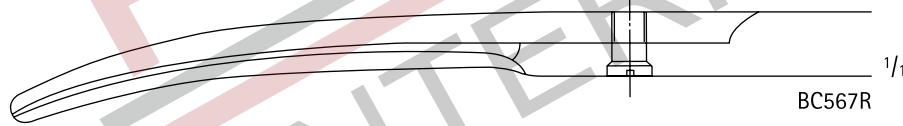

BC567R

¹/₁

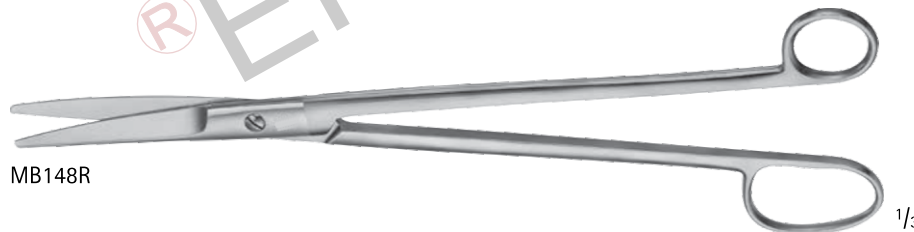

MB148R

¹/₃

**MAYO Dissecting Scissors, W/ One
Large Ring**

Catalog Number	Tip	Blade	Length (in.)
MB148R	B/B	HEAVY	14

¹/₁
MB148R

**MAYO Dissecting Scissors, Beveled
Blade**

Catalog Number	Tip	Blade	Length (in.)
BC544R	B/B	STR	5 1/2
BC545R	B/B	STR	6 1/8
BC547R	B/B	STR	6 3/4
BC562R	B/B	STR	7 1/2
BC564R	B/B	STR	8 1/2
BC554R	B/B	CVD	5 1/2
BC555R	B/B	CVD	6 1/8
BC557R	B/B	CVD	6 3/4
BC563R	B/B	CVD	7 1/2
BC565R	B/B	CVD	8 1/2

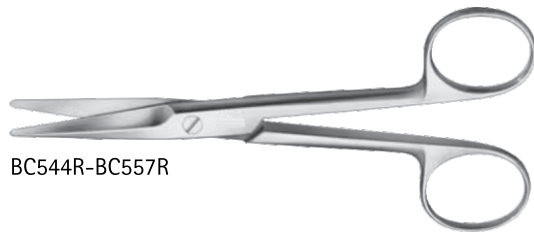

BC544R-BC557R

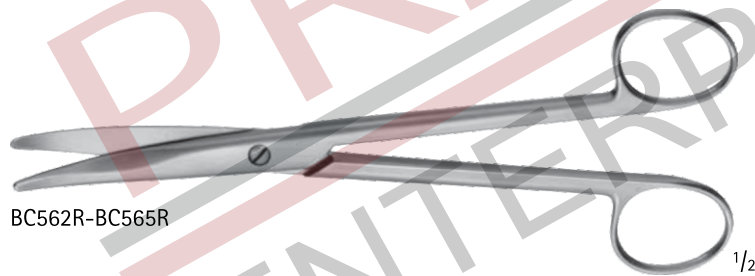

BC562R-BC565R

1/1
BC544R

1/1
BC545R

1/1
BC547R

1/1
BC554R

1/1
BC555R

1/1
BC557R

1/1
BC562R

1/1
BC564R

1/1
BC563R

1/1
BC565R

MAYO Operating Scissors

Catalog Number	Tip	Blade	Length (in.)
BC466R	S/S	STR	5 1/2
BC467R	S/S	CVD	5 1/2

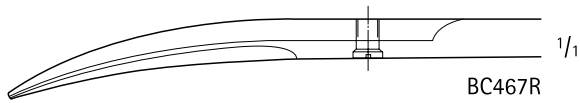
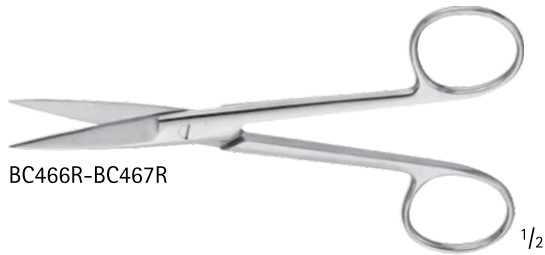

MAYO Dissecting Scissors, Delicate

Catalog Number	Tip	Blade	Length (in.)
BC594R	B/B	STR	5 1/2

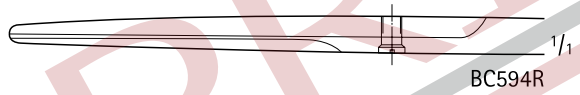

NEW'S Suture Scissors

Catalog Number	Tip	Blade	Length (in.)
BC804R	B/B	ANG	5 1/2

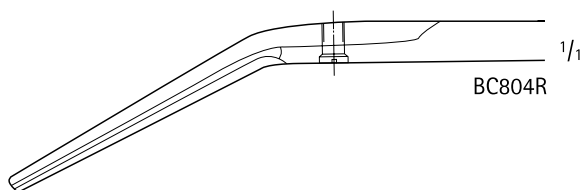

Suture Scissors

Catalog Number	Tip	Blade	Length (in.)
BC806R	B/B	STR	4 1/2

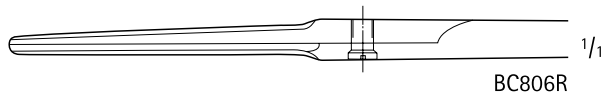

LEXER Dissecting Scissors, Delicate

Catalog Number	Tip	Blade	Length (in.)
BC590R	B/B	STR	6 1/2
BC591R	B/B	CVD	6 1/2

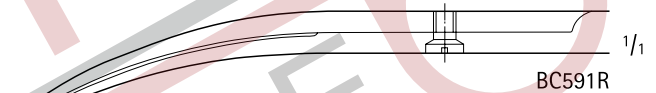
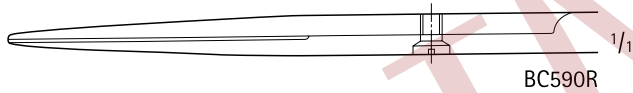
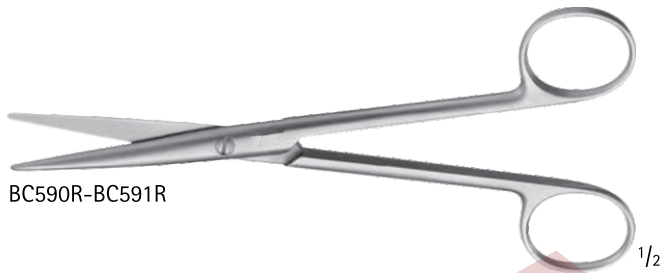

MAYO-LEXER Dissecting Scissors

Catalog Number	Tip	Blade	Length (in.)
BC592R	B/B	CVD	6 1/2

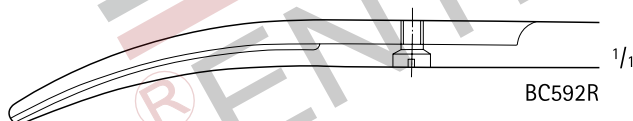
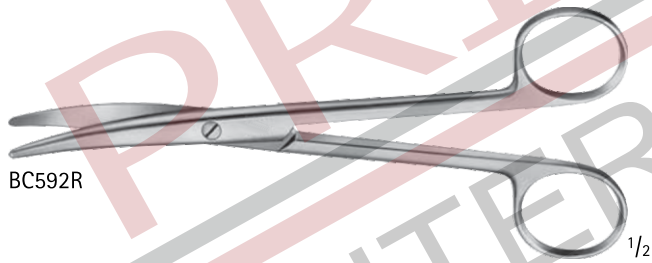

MAYO-SIMS Dissecting Scissors

Catalog Number	Tip	Blade	Length (in.)
MB149R	B/B	STR	7 3/4

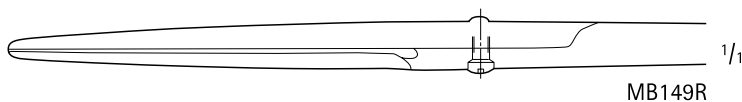

**MAYO–NOBLE Dissecting Scissors,
Broad Blade**

Catalog Number	Tip	Blade	Length (in.)
BC566R	B/B	STR	6 3/4
BC569R	B/B	CVD	6 3/4

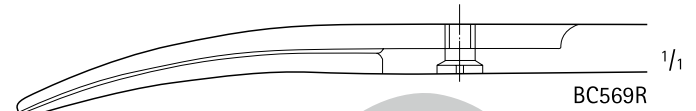
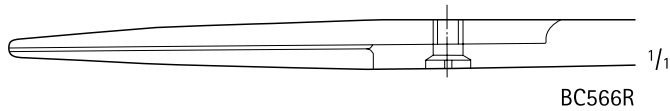
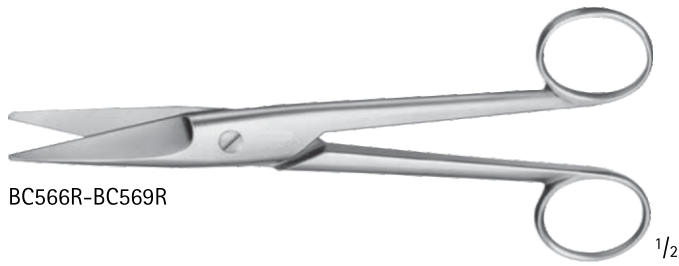

**MAYO–STILLE Dissecting Scissors,
Beveled Blade**

Catalog Number	Tip	Blade	Length (in.)
BC576R	B/B	STR	5 1/2
BC578R	B/B	STR	6 1/2
BC577R	B/B	CVD	5 1/2
BC579R	B/B	CVD	6 1/2

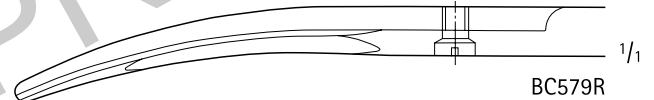
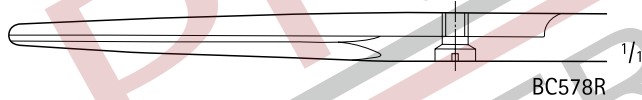
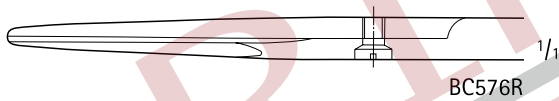

**MAYO–STILLE Dissecting Scissors,
Flat Blade**

Catalog Number	Tip	Blade	Length (in.)
BC570R	B/B	STR	5 1/2
BC572R	B/B	STR	6 3/4
BC573R	B/B	CVD	5 1/2
BC575R	B/B	CVD	6 3/4

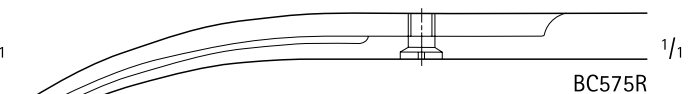
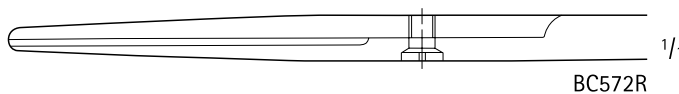
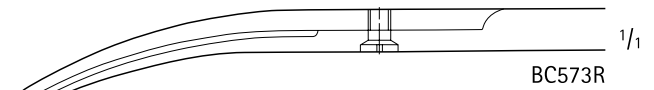
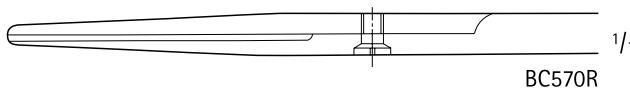
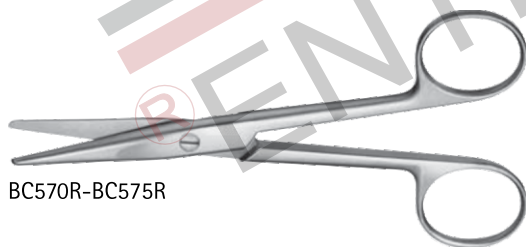

TOENNIS Dissecting Scissors

Catalog Number	Tip	Blade	Length (in.)
BC633R	B/B	X-DEL, STR	7
BC634R	B/B	DEL, STR	7
BC635R	B/B	DEL, CVD	7

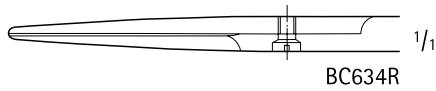
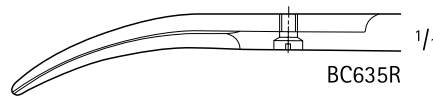
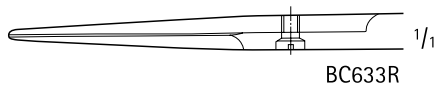

Nerve Dissecting Scissors

Catalog Number	Tip	Blade	Length (in.)
BC628R	S/S	CVD	6

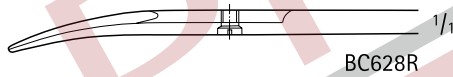
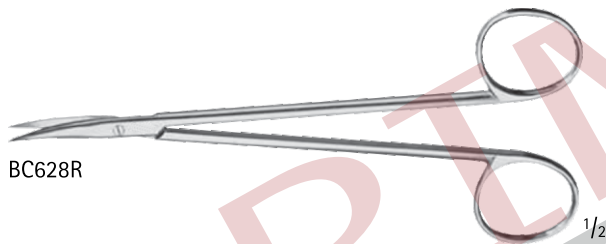

TOENNIS-ADSON Dissecting Scissors

Catalog Number	Tip	Blade	Length (in.)
BC630R	X-DEL	CVD	6 7/8
BC631R	DEL	CVD	6 7/8

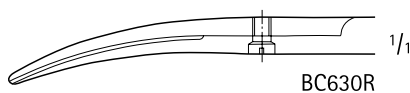



BC601R-BC607R

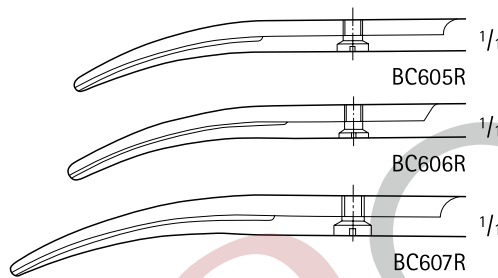
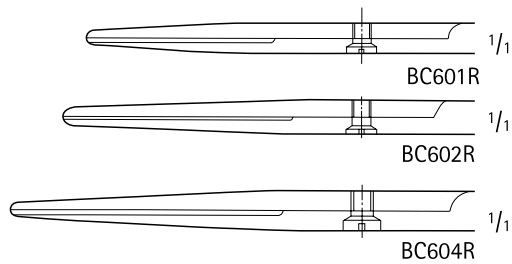

METZENBAUM Dissecting Scissors

Catalog Number	Tip	Blade	Length (in.)
BC601R	B/B	STR	5 3/4
BC602R	B/B	STR	7
BC604R	B/B	STR	7 7/8
BC605R	B/B	CVD	5 3/4
BC606R	B/B	CVD	7
BC607R	B/B	CVD	7 7/8



BC600R-BC603R

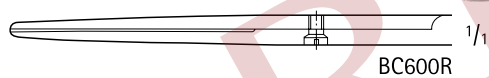

Baby METZENBAUM Dissecting Scissors, Delicate

Catalog Number	Tip	Blade	Length (in.)
BC600R	B/B	STR	5 3/4
BC603R	B/B	CVD	5 3/4

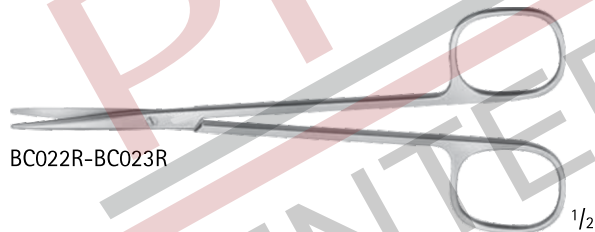

BC022R-BC023R

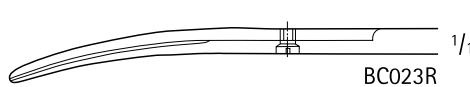
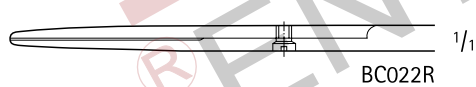

Baby METZENBAUM Dissecting Scissors

Catalog Number	Tip	Blade	Length (in.)
BC022R	B/B	STR	5 3/4
BC023R	B/B	CVD	5 3/4

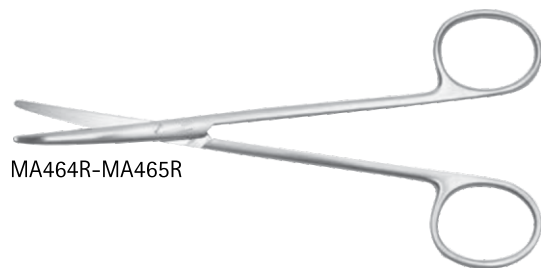

MA464R-MA465R

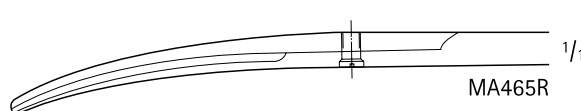

METZENBAUM Scissors, Delicate

Catalog Number	Tip	Blade	Length (in.)
MA464R	B/B	CVD	5 1/2
MA465R	B/B	CVD	8

**NELSON-METZENBAUM Dissecting
Scissors**

Catalog Number	Tip	Blade	Length (in.)
BC611R	B/B	STR	9
BC612R	B/B	STR	9 3/4
BC613R	B/B	STR	11 1/4
BC614R	B/B	STR	12
BC615R	B/B	CVD	9
BC616R	B/B	CVD	9 3/4
BC618R	B/B	CVD	11 1/4
BC619R	B/B	CVD	12
MB926R	B/B	CVD	16

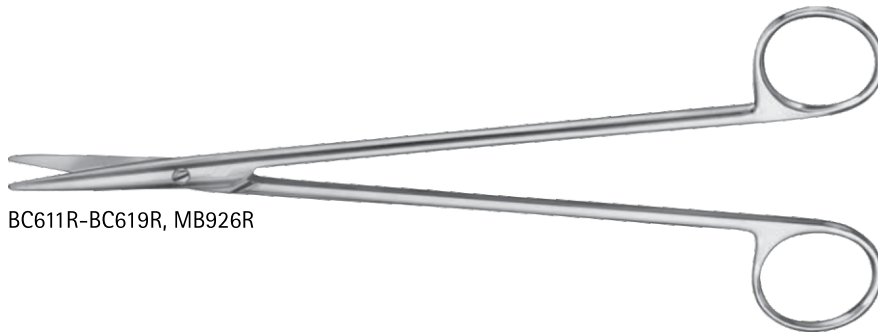

BC611R-BC619R, MB926R

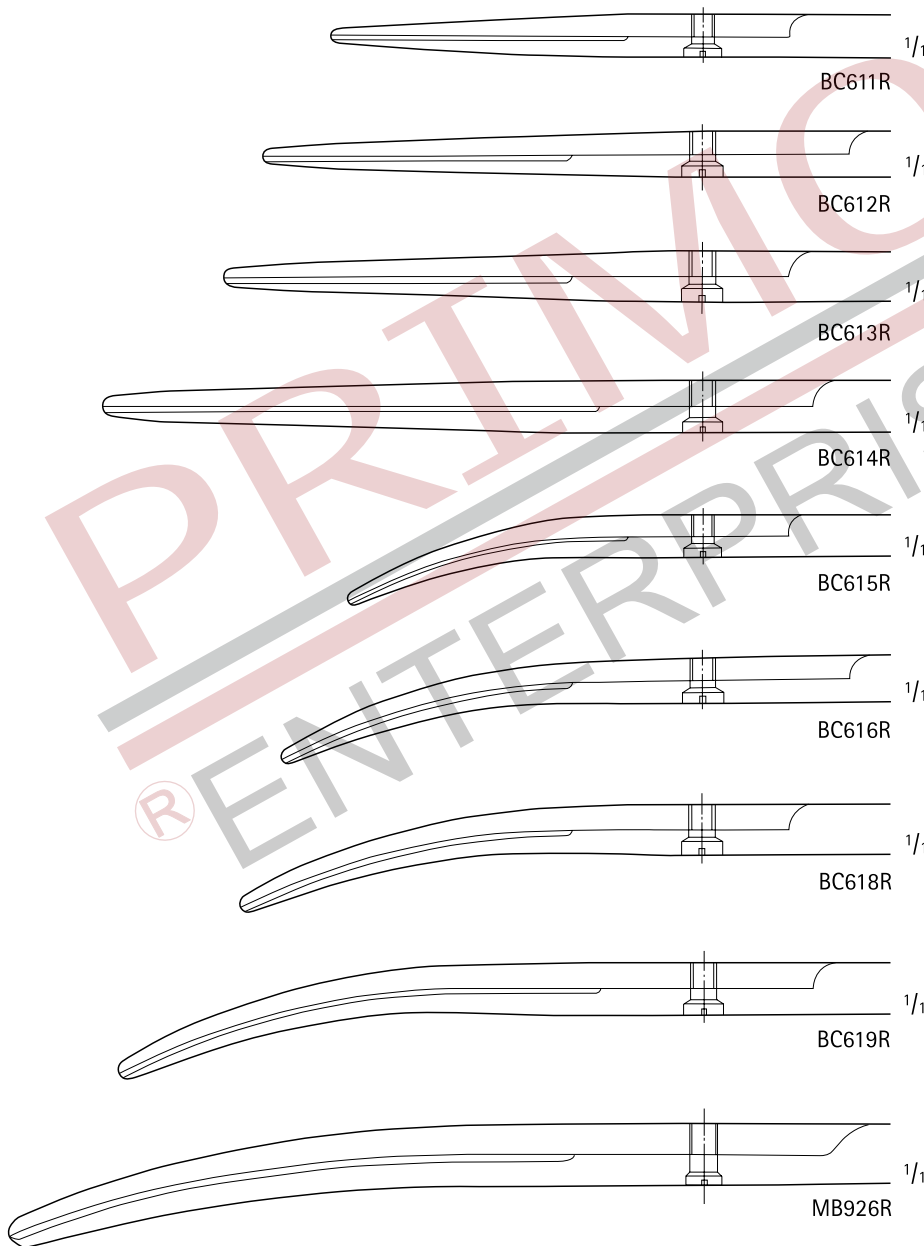

**NELSON-METZENBAUM Dissecting
Scissors, Delicate**

Catalog Number	Tip	Blade	Length (in.)
BC625R	B/B	CVD	13 3/4

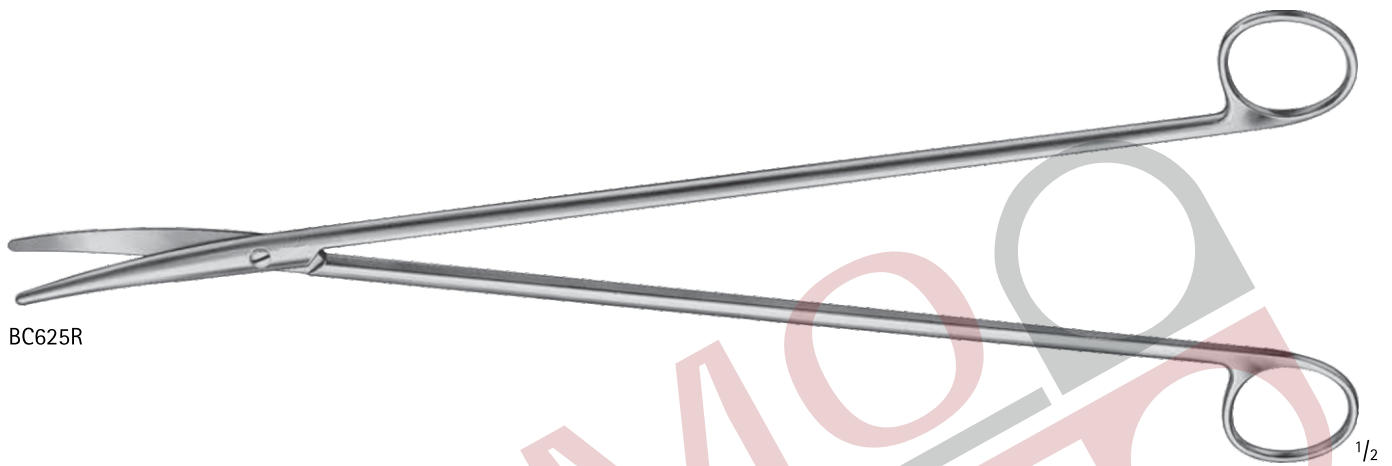

BC625R

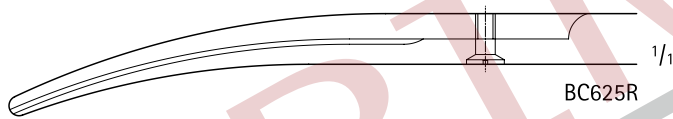

WELLER Dissecting Scissors

Catalog Number	Tip	Blade	Length (in.)
BC620R	B/B	HEAVY-CVD	11



BC620R

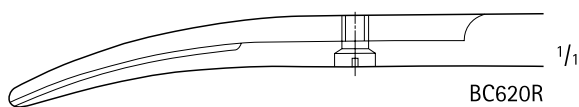

Abdominal Scissors

Catalog Number	Tip	Blade	Length (in.)
BC774R	B/B	STR	7

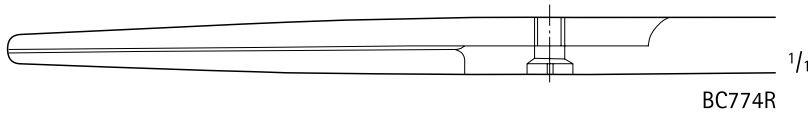

Rectal Scissors

Catalog Number	Tip	Blade	Length (in.)
BC617R	B/B	HEAVY-CVD	12 3/4

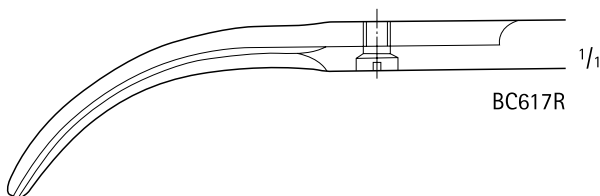

LLOYD-DAVIES Rectal Scissors

Catalog Number	Tip	Blade	Length (in.)
BC621R	B/B	CVD	10 5/8



BC621R

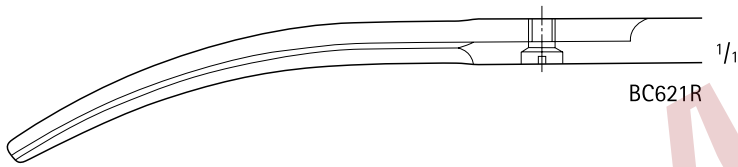

BC621R

STELZNER Rectal Scissors

Catalog Number	Tip	Blade	Length (in.)
BC622R	B/B	STR	12 1/4
BC623R	B/B	CVD	12 1/4



BC622R-BC623R

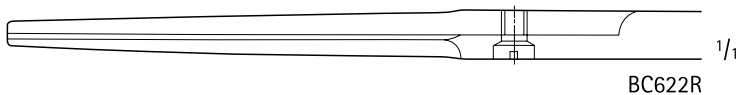

BC622R



BC623R

MUELLER Rectal Scissors

Catalog Number	Tip	Blade	Length (in.)
BC627R	B/B	CVD	12 3/4

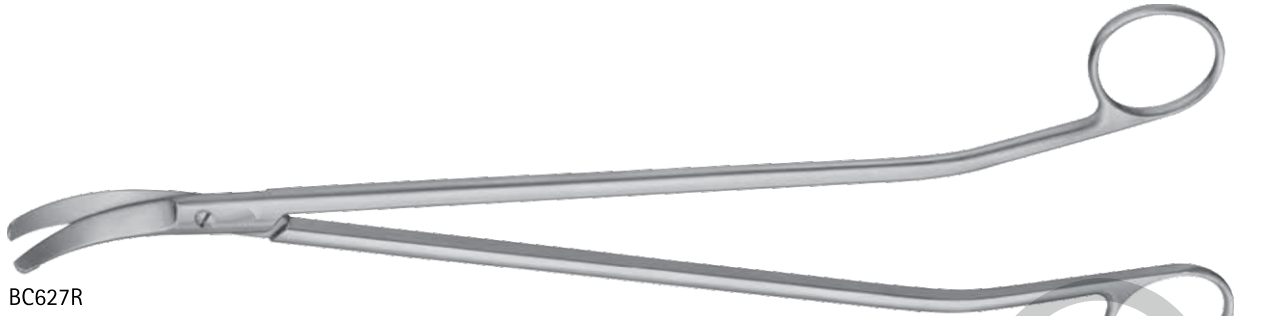

BC627R

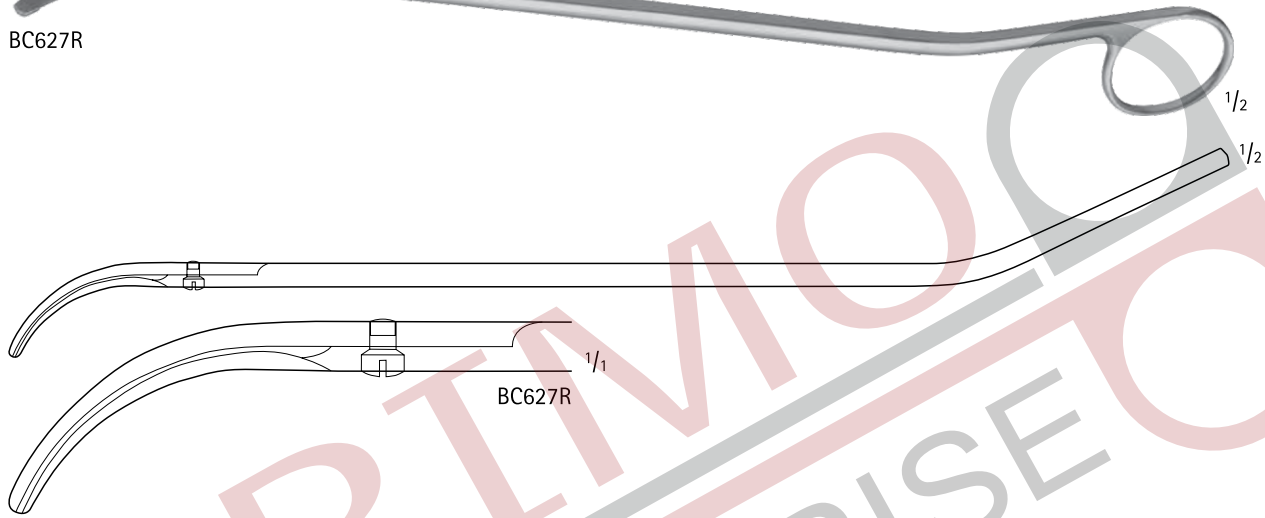

BC627R

HARVEY Wire Scissors

Catalog Number	Tip	Blade	Length (in.)
BC815R	B/B	SERR	5

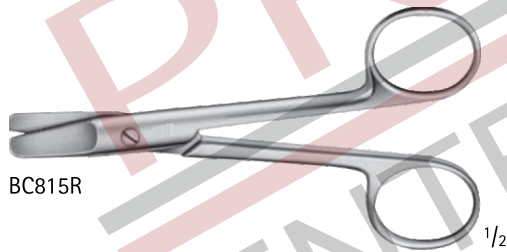

BC815R

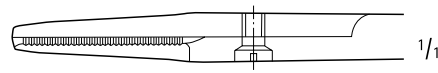

BC815R

Wire Cutting Scissors

Catalog Number	For Wire Size	Length (in.)
DP551R	SOFT, UP TO 1.2MM AND HARD, UP TO 0.6 MM	4 3/4



DP551R

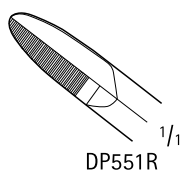

DP551R

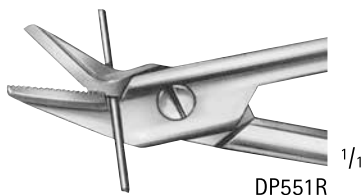

DP551R

Iris Scissors

Catalog Number	Tip	Blade	Length (in.)
BC100R	S/S	STR	3 1/2
BC110R	S/S	STR	4 1/4
BC106R	S/S	STR	4 1/2
BC064R	S/S	STR	4 3/4
BC101R	S/S	CVD	3 1/2
BC111R	S/S	CVD	4 1/4
BC107R	S/S	CVD	4 1/2
BC065R	S/S	CVD	4 3/4
BC112R	S/B	STR	4 1/4
BC113R	S/B	CVD	4 1/4
BC117R	S/S	LAT-ANG	4 1/4

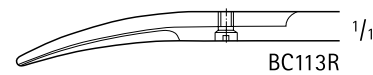
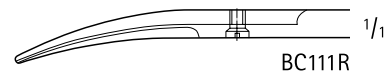
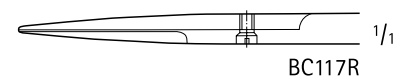
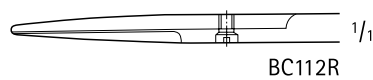
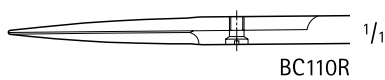
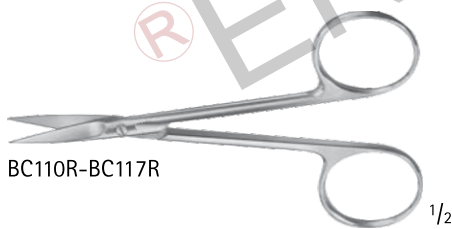
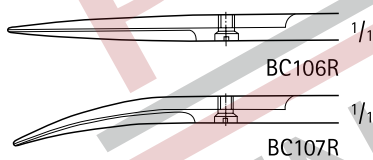
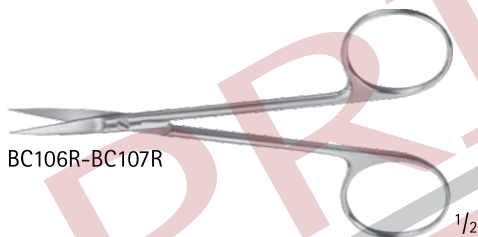
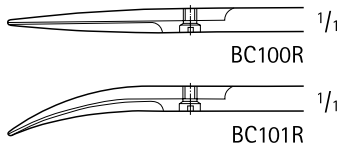
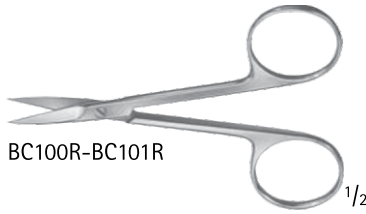
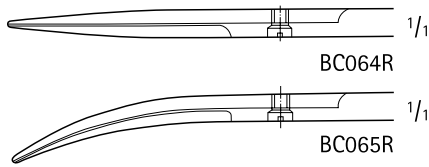

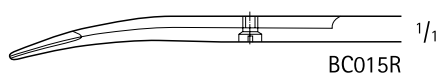

REYNOLDS-JAMESON Tenotomy Scissors

Catalog Number	Tip	Blade	Handle	Length (in.)
BC015R	B/B	CVD	SQUARE	5 1/2

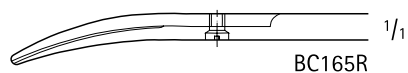
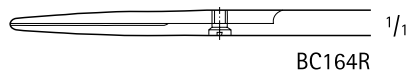
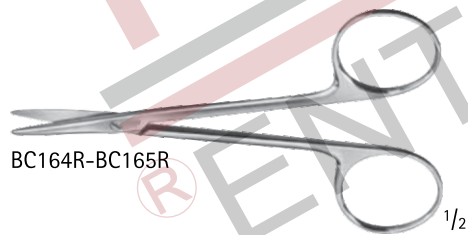

Strabismus Scissors

Catalog Number	Tip	Blade	Length (in.)
BC164R	B/B	STR	4 1/2
BC165R	B/B	CVD	4 1/2

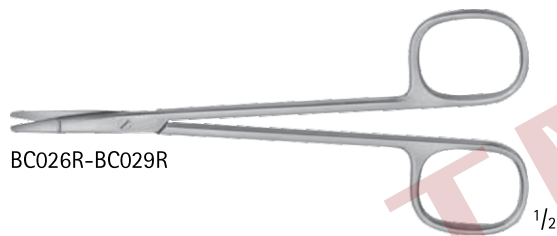

RAGNELL Dissecting Scissors

Catalog Number	Tip	Blade	Length (in.)
BC026R	B/B	STR	5 1/4
BC027R	B/B	CVD	5 1/4
BC029R	B/B	CVD	6

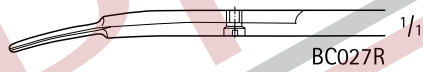
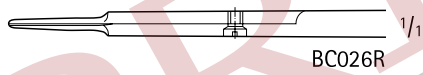

CHADWICK Scissors, Delicate

Catalog Number	Tip	Blade	Length (in.)
BC153R	S/S	CVD	4 1/2

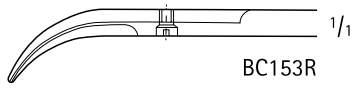

LA GRANGE Scissors

Catalog Number	Tip	Blade	Length (in.)
BC154R	S/S	1-SERR	4 1/4

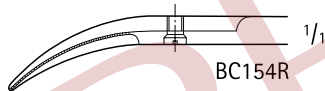

KELLY Scissors

Catalog Number	Tip	Blade	Length (in.)
BC160R	S/S	STR	6 7/8
BC161R	S/S	CVD	6 7/8

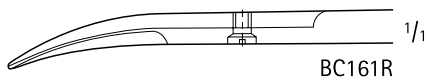
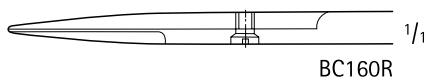

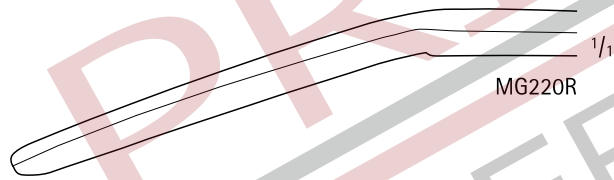
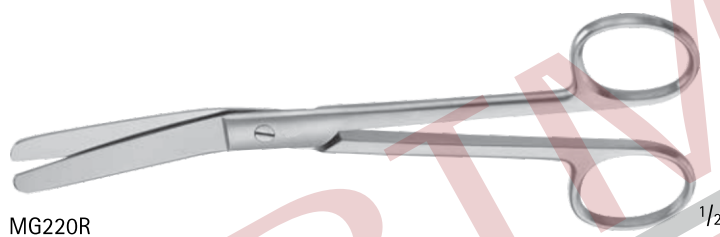

ROCHESTER-FERGUSON Scissors

Catalog Number	Tip	Blade	Length (in.)
MG220R	B/B	ANG FLAT	7

DUROTIP Tungsten Carbide Scissors

- Excellent cutting accuracy
- Long working life
- Gold-plated rings

DUROTIP TC Suture Scissors

Catalog Number	Tip	Blade	Length (in.)
BC228R	S/S	STR	5 3/4
BC224R	S/B	STR	5 3/4
BC234R	S/B	CVD	5 3/4

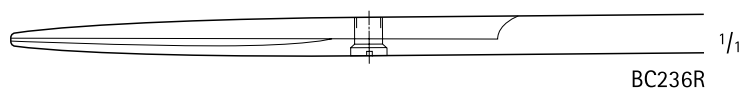
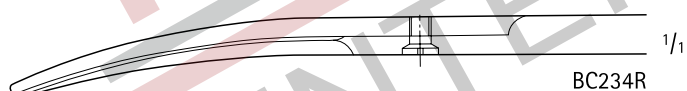
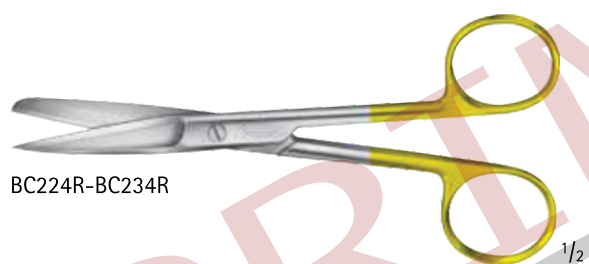
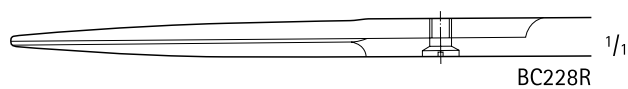
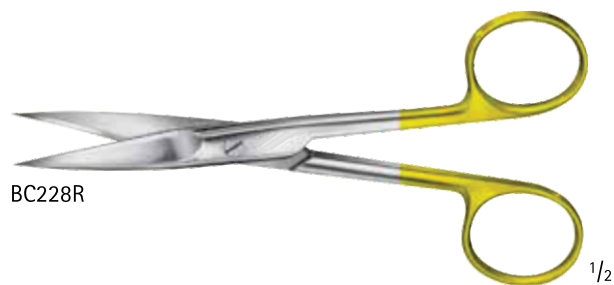

DUROTIP TC Operating Scissors

Catalog Number	Tip	Blade	Length (in.)
BC236R	S/S	STR	5 3/4
MB171R	S/S	CVD	5 3/4

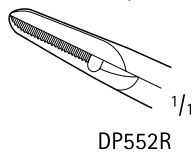
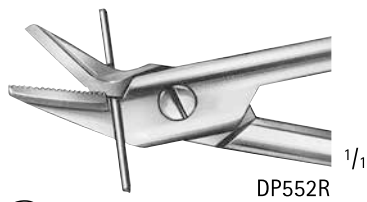
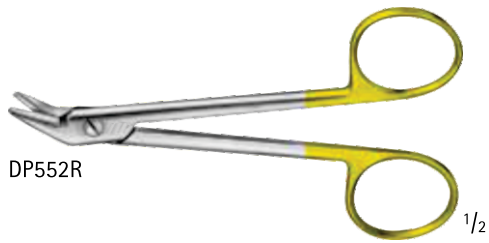

DUROTIP TC Wire Cutting Scissors

Catalog Number	Blade	For Wire Size	Length (in.)
DP552R	1-SERR	SOFT, UP TO 1.2 MM AND HARD, UP TO 0.8 MM	4 3/4

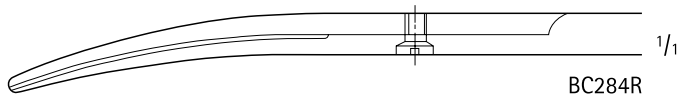
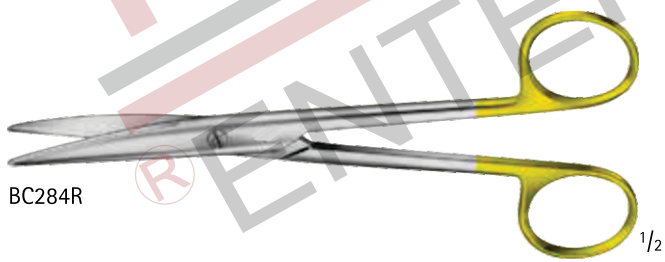

DUROTIP TC MAYO-LEXER Dissecting Scissors, Round Blades

Catalog Number	Tip	Blade	Length (in.)
BC284R	B/B	CVD	6 1/2

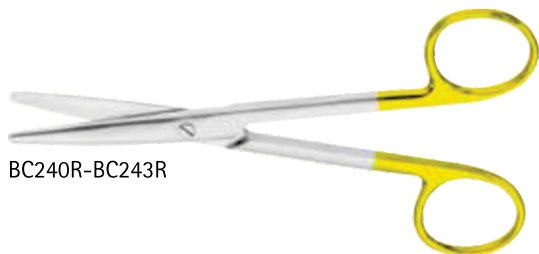

BC240R-BC243R

**DUROTIP TC MAYO Dissecting Scissors,
Round Blades**

Catalog Number	Tip	Blade	Length (in.)
BC240R	B/B	STR	5 1/2
BC242R	B/B	STR	6 3/4
BC241R	B/B	CVD	5 1/2
BC243R	B/B	CVD	6 3/4

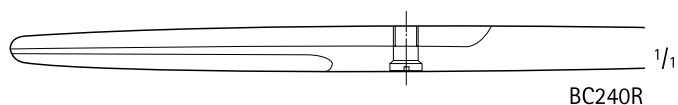

BC240R

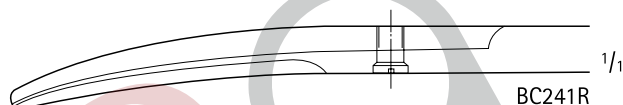

BC241R

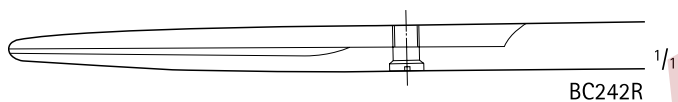

BC242R

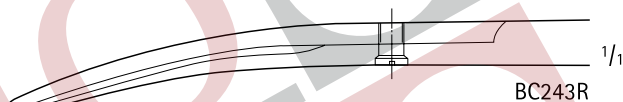

BC243R



BC250R-BC253R

**DUROTIP TC MAYO Dissecting Scissors,
Beveled Blades**

Catalog Number	Tip	Blade	Length (in.)
BC250R	B/B	STR	5 1/2
BC252R	B/B	STR	6 3/4
BC251R	B/B	CVD	5 1/2
BC253R	B/B	CVD	6 3/4

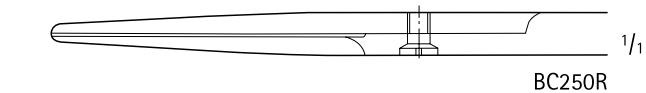

BC250R

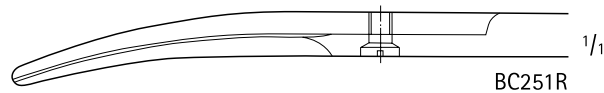

BC251R

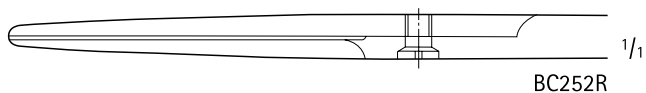

BC252R

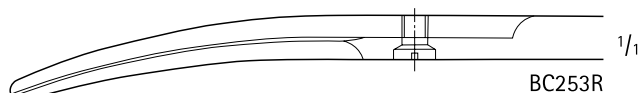

BC253R

DUROTIP TC MAYO Dissecting Scissors

Catalog Number	Tip	Blade	Length (in.)
BC558R	B/B	STR	9
MG215R	B/B	STR	14
BC559R	B/B	CVD	9
MB726R	B/B	CVD	14



BC558R-BC559R, MB726R

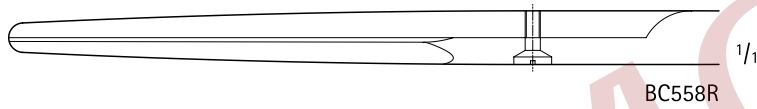

BC558R

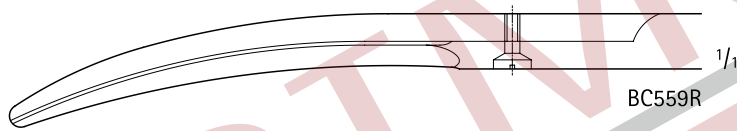

BC559R

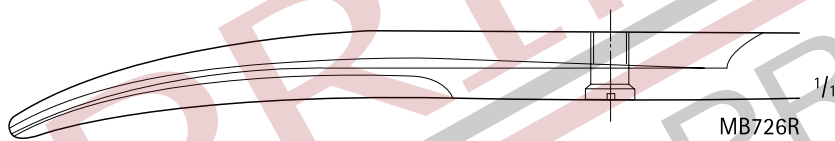

MB726R



MG215R

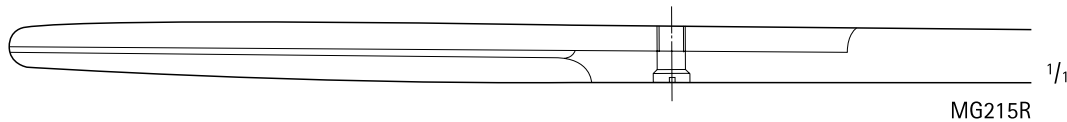

MG215R

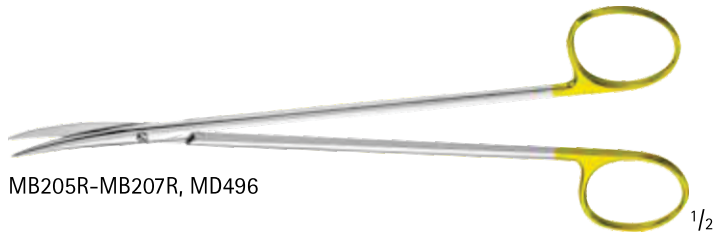

MB205R-MB207R, MD496



MB205R

**DUROTIP TC METZENBAUM Dissecting
Scissors, Delicate**

Catalog Number	Tip	Blade	Length (in.)
MB205R	S/S	STR	9 1/4
MB207R	S/S	CVD	5 3/4
MD496	S/S	CVD	7
MB206R	S/S	CVD	9 1/4

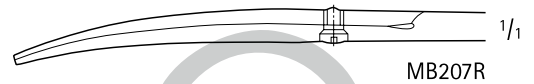

MB207R



MD496



MB206R

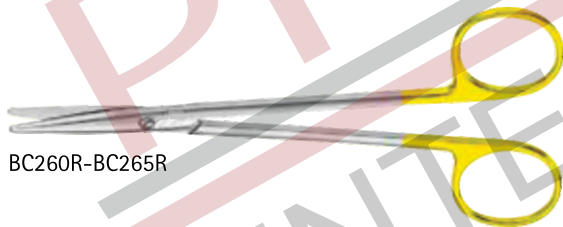

BC260R-BC265R

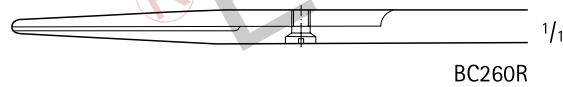

BC260R

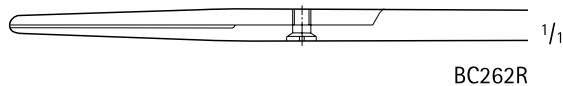

BC262R

**DUROTIP TC METZENBAUM Dissecting
Scissors**

Catalog Number	Tip	Blade	Length (in.)
BC260R	B/B	STR	5 3/4
BC262R	B/B	STR	7
BC261R	B/B	CVD	5 3/4
BC263R	B/B	CVD	7
BC265R	B/B	CVD	7 7/8

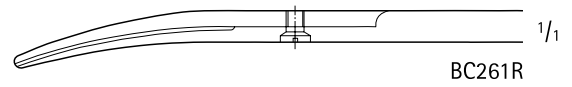

BC261R

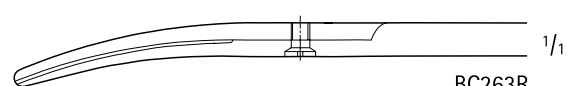

BC263R

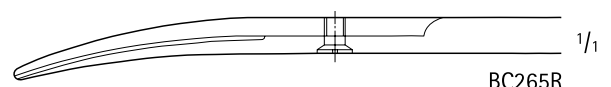

BC265R



BC287R

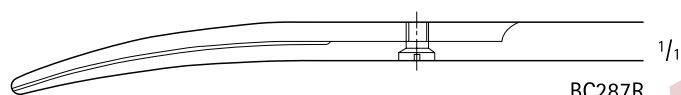

BC287R

DUROTIP TC METZENBAUM Dissecting Scissors

Catalog Number	Tip	Blade	Length (in.)
BC287R	B/B	CVD	9

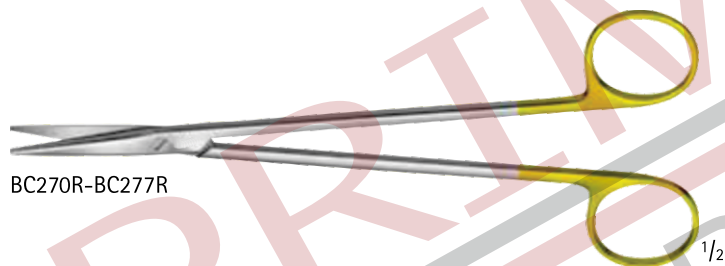

BC270R-BC277R

DUROTIP TC METZENBAUM Dissecting Scissors, Delicate

Catalog Number	Tip	Blade	Length (in.)
BC270R	B/B	STR	7
BC274R	B/B	STR	7 7/8
BC276R	B/B	STR	9
BC271R	B/B	CVD	7
BC275R	B/B	CVD	7 7/8
BC277R	B/B	CVD	9

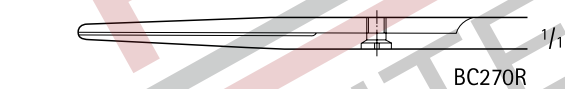

BC270R

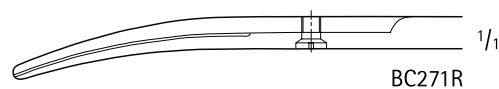

BC271R

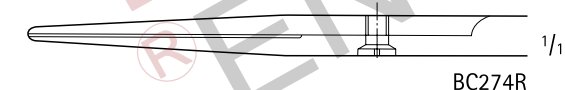

BC274R

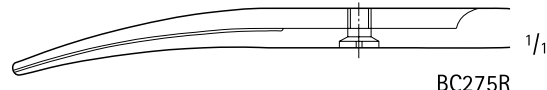

BC275R

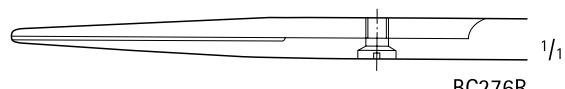

BC276R

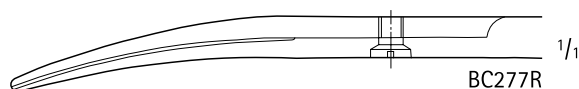

BC277R



BC258R-BC259R

**DUROTIP TC Baby METZENBAUM
Dissecting Scissors, Delicate**

Catalog Number	Tip	Blade	Length (in.)
BC258R	B/B	STR	5 3/4
BC259R	B/B	CVD	5 3/4

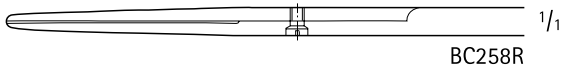

BC258R

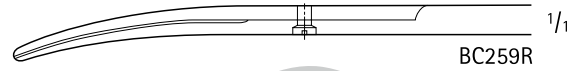

BC259R

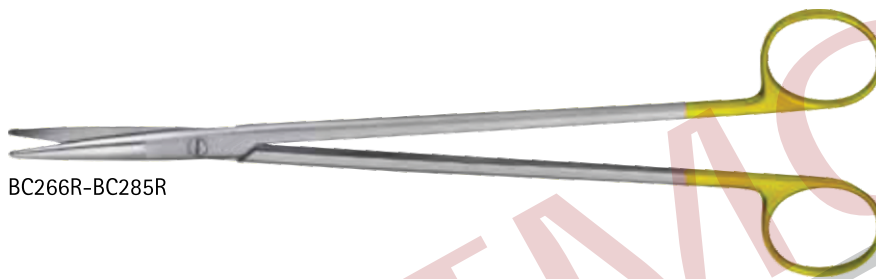

BC266R-BC285R

**DUROTIP TC NELSON-METZENBAUM
Dissecting Scissors**

Catalog Number	Tip	Blade	Length (in.)
BC266R	B/B	STR	9
BC267R	B/B	CVD	9
BC279R	B/B	CVD	10 1/4
BC281R	B/B	CVD	11
BC282R	B/B	CVD	11 1/4
BC289R	B/B	CVD	11 3/4
BC285R	B/B	CVD	13 3/4

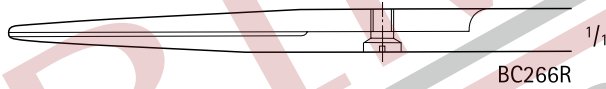

BC266R

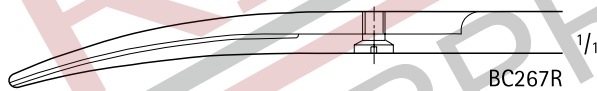

BC267R

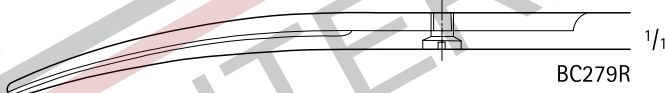

BC279R



BC281R

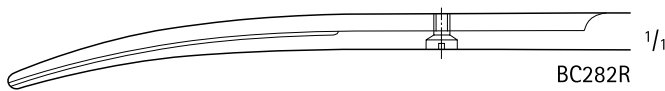

BC282R

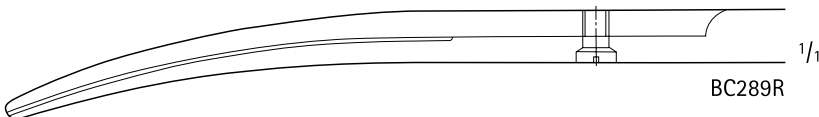

BC289R

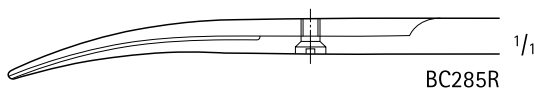

BC285R



BC273R

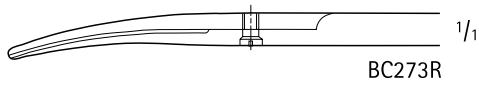

BC273R

**DUROTIP TC TOENNIS-ADSON
Dissecting Scissors, Delicate**

Catalog Number	Tip	Blade	Length (in.)
BC273R	B/B	CVD	6 7/8

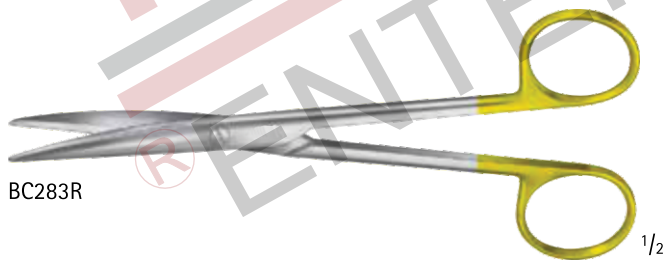

BC283R

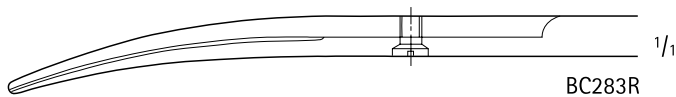

BC283R

**DUROTIP TC LEXER Dissecting Scissors,
Delicate**

Catalog Number	Tip	Blade	Length (in.)
BC283R	B/B	CVD	6 1/2



Wavecut

- Wavecut scissors have one serrated cutting edge to prevent tissue from slipping. The W after the item number indicates the scissors are the wavecut style, e.g. BC211W.



BC253W

DUROTIP TC MAYO Wavecut Dissecting Scissors, Beveled Blades

Catalog Number	Tip	Blade	Length (in.)
BC253W	B/B	CVD	6 3/4

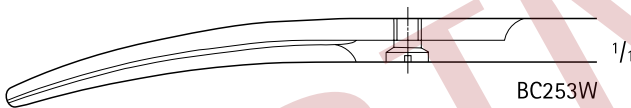

BC253W

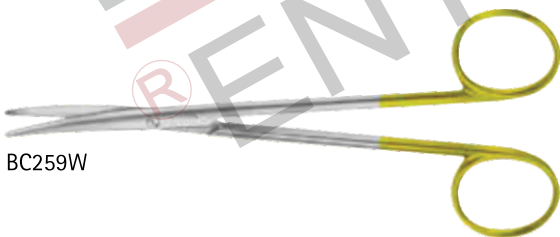

BC259W

DUROTIP TC Baby METZENBAUM Wavecut Dissecting Scissors, Delicate

Catalog Number	Tip	Blade	Length (in.)
BC259W	B/B	CVD	5 3/4

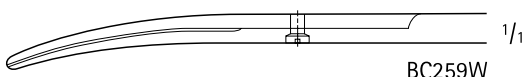

BC259W

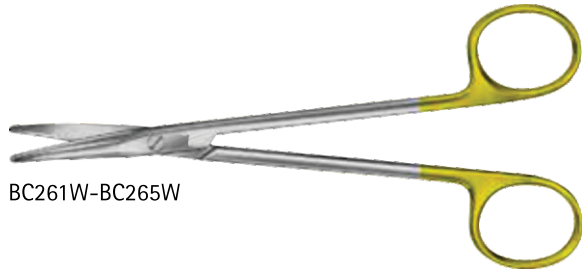

BC261W-BC265W

**DUROTIP TC METZENBAUM Wavecut
Dissecting Scissors**

Catalog Number	Tip	Blade	Length (in.)
BC261W	B/B	CVD	5 3/4
BC263W	B/B	CVD	7
BC265W	B/B	CVD	7 7/8

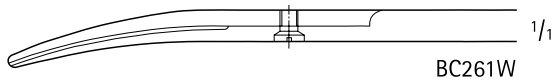

BC261W

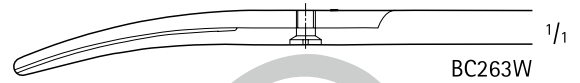

BC263W

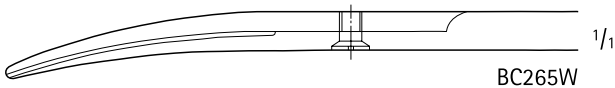

BC265W

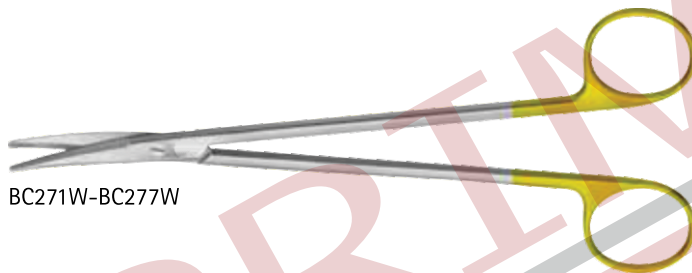

BC271W-BC277W

**DUROTIP TC METZENBAUM Wavecut
Dissecting Scissors, Delicate**

Catalog Number	Tip	Blade	Length (in.)
BC271W	B/B	CVD	7
BC275W	B/B	CVD	7 7/8
BC277W	B/B	CVD	9

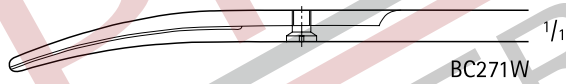

BC271W

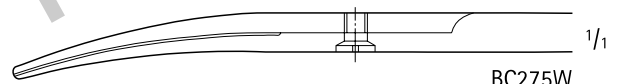

BC275W

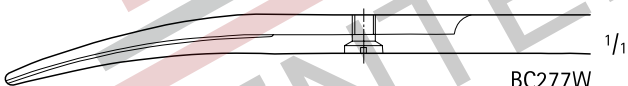

BC277W



BC287W

**DUROTIP TC METZENBAUM
Wavecut Dissecting Scissors, Heavy**

Catalog Number	Tip	Blade	Length (in.)
BC287W	B/B	CVD	9

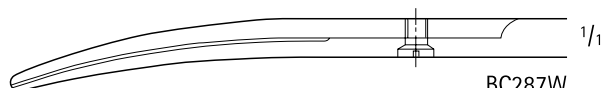

BC287W

**DUROTIP TC TOENNIS-ADSON Wavecut
Dissecting Scissors**

Catalog Number	Tip	Blade	Length (in.)
BC273W	B/B	CVD	6 7/8

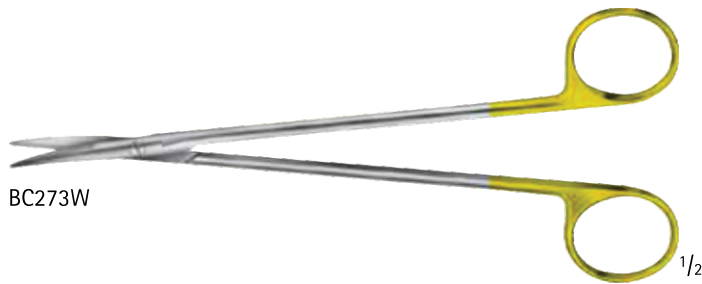

BC273W

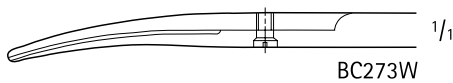

BC273W

**DUROTIP TC NELSON-METZENBAUM
Wavecut Dissecting Scissors**

Catalog Number	Tip	Blade	Length (in.)
BC267W	B/B	CVD	9
BC279W	B/B	CVD	10 1/4
BC281W	B/B	CVD	11

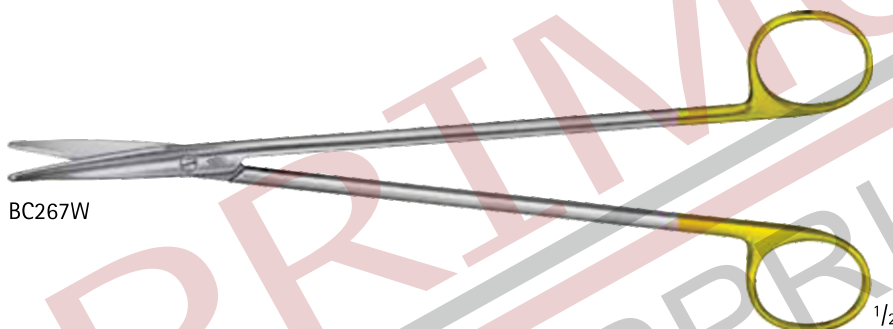

BC267W



BC267W



BC279W-BC281W

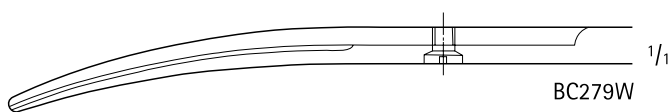

BC279W

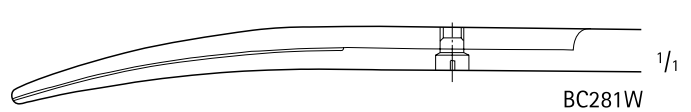

BC281W

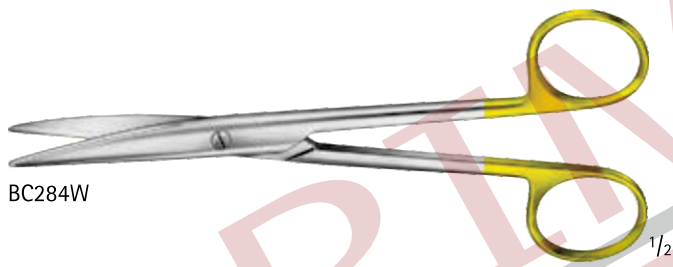

BC284W

DUROTIP TC MAYO-LEXER Wavecut
Scissors

Catalog Number	Tip	Blade	Length (in.)
BC284W	B/B	CVD	6 1/2

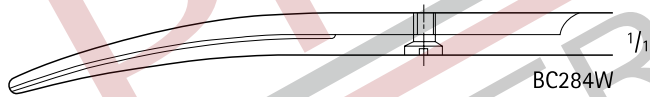

BC284W

1/2

1/1

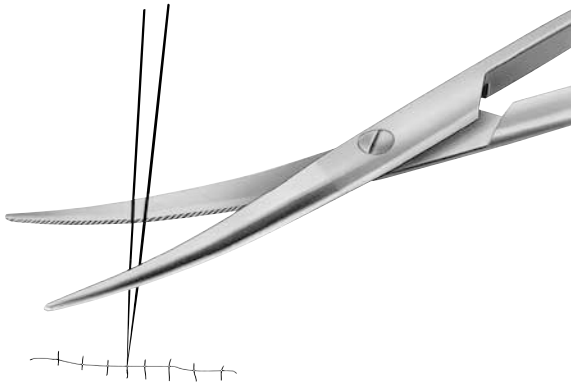

DUROTIP TC Ligature Scissors

- Carbide inserts guarantee permanent sharp cutting edge (also in the distal area of the blades).
- Wavecut prevents suture materials from slipping.
- Identified by 1 gold-plated ring.



BC294W-BC298W

DUROTIP TC Ligature Wavecut Scissors

Catalog Number	Tip	Blade	Length (in.)
BC294W	B/B	CVD	5 3/4
BC295W	B/B	CVD	7
BC296W	B/B	CVD	9
BC297W	B/B	CVD	10 1/4
BC298W	B/B	CVD	13 3/4

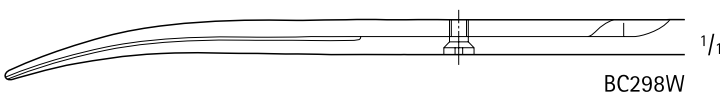
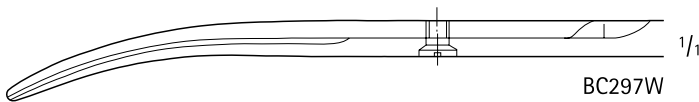
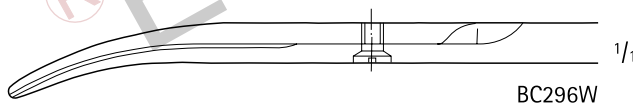
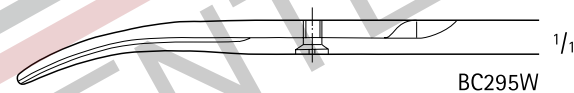
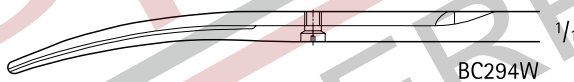

SuperCut Scissors

Your everyday black handle scissors

- Microtome Edge
 - Razor sharp cutting edge facilitates gentle cutting with minimal force
- Wavecut Blade
 - Prevents tissue from slipping out during the cutting process

For more information about SuperCut Scissors see brochure number DOC821.

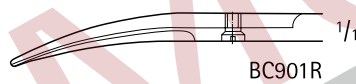
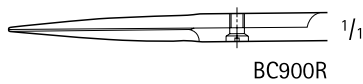

Iris SuperCut Scissors, Delicate

Catalog Number	Tip	Blade	Length (in.)
BC900R	S/S	STR	4 1/4
BC901R	S/S	CVD	4 1/4

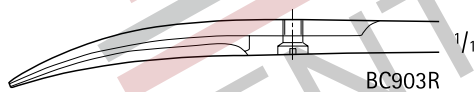

SuperCut Plastic Standard Scissors

Catalog Number	Tip	Blade	Length (in.)
BC903R	S/S	CVD	5

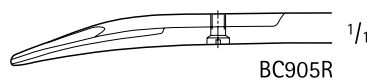
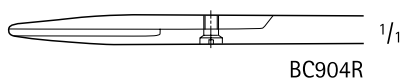

STEVENS SuperCut Scissors

Catalog Number	Tip	Tip Size (mm)	Blade	Length (in.)
BC904R	B/B	12	STR	4 1/8
BC905R	B/B	12	CVD	4 1/8

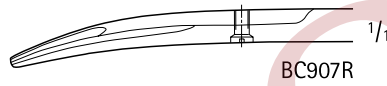
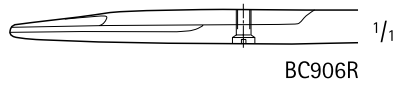
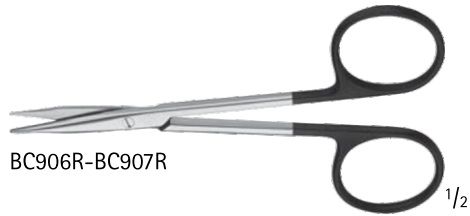

STEVENS SuperCut Scissors (continued)

Catalog Number	Tip	Tip Size (mm)	Blade	Length (in.)
BC906R	B/B	13	STR	4 1/4
BC907R	B/B	13	CVD	4 1/4

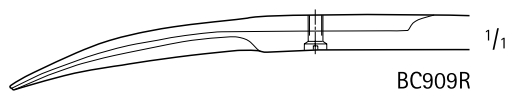
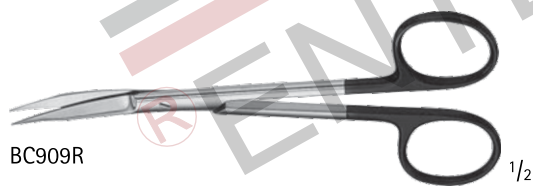

GOLDMANN-FOX SuperCut Scissors

Catalog Number	Tip	Blade	Length (in.)
BC909R	S/S	CVD	5 1/8

JAMESON SuperCut Scissors, Delicate

Catalog Number	Tip	Blade	Length (in.)
BC911R	B/B	CVD	5 1/8
BC915R	B/B	CVD	6
BC919R	B/B	CVD	7

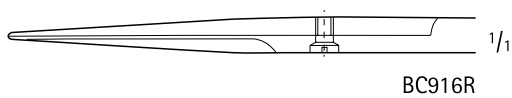
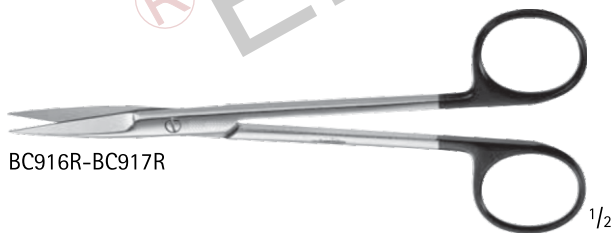
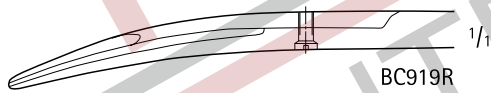
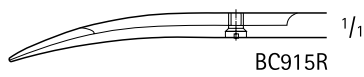

JOSEPH SuperCut Scissors, Delicate

Catalog Number	Tip	Blade	Length (in.)
BC916R	S/S	STR	6
BC917R	S/S	CVD	6

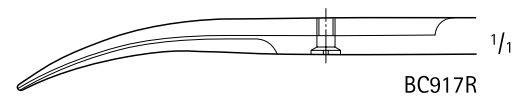

GORNEY SuperCut Scissors, Delicate

Catalog Number	Tip	Blade	Length (in.)
BC920R	B/B	STR	7 3/4
BC921R	B/B	CVD	7 3/4



BC920R-BC921R

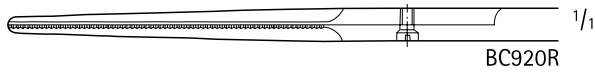

BC920R

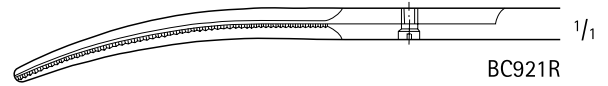

BC921R

KAYE SuperCut Facelift Scissors, Delicate

Catalog Number	Tip	Blade	Length (in.)
BC933R	B/B	CVD	7 3/4



BC933R

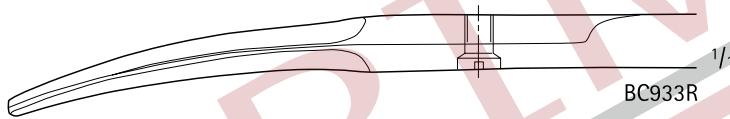

BC933R

MAYO SuperCut Scissors, Delicate

Catalog Number	Tip	Blade	Length (in.)
BC926R	B/B	STR, BEVELED	5 3/4
BC927R	B/B	CVD, BEVELED	5 3/4
BC924R	B/B	STR, ROUND	6 1/2
BC925R	B/B	CVD, ROUND	6 1/2

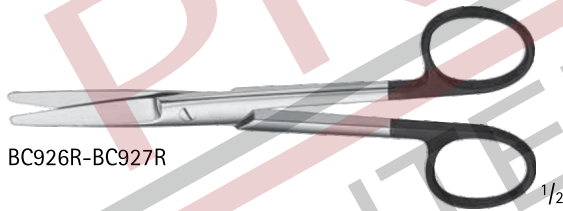

BC926R-BC927R

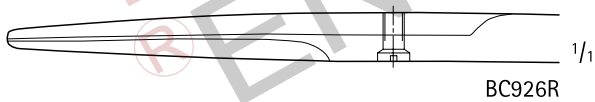

BC926R

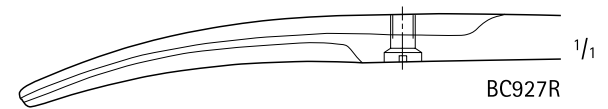

BC927R



BC924R-BC925R

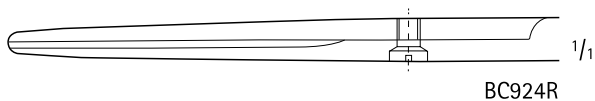

BC924R

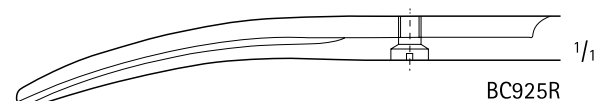

BC925R

MAYO SuperCut Scissors, Beveled

Catalog Number	Tip	Blade	Length (in.)
MG216R	B/B	STR	9
BC922R	B/B	STR	10
BC938R	B/B	STR	12
MG087R	B/B	CVD	9
BC929R	B/B	CVD	11



BC922R-MG216R

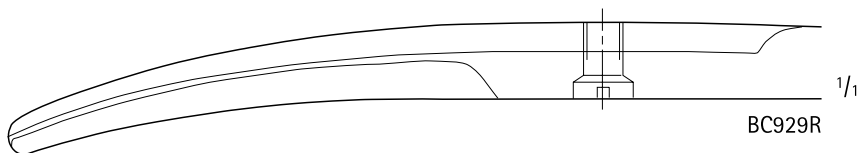
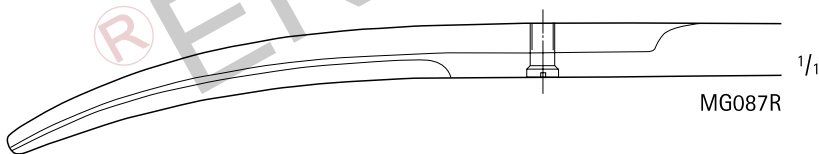
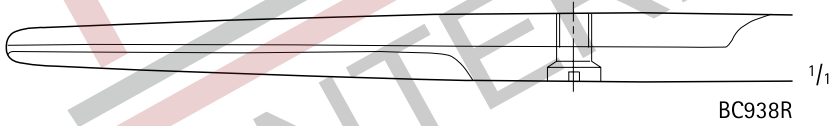
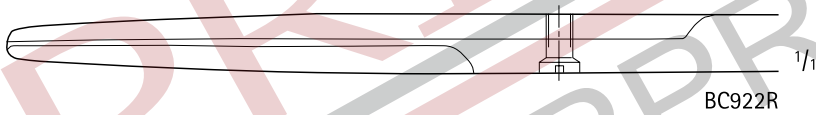
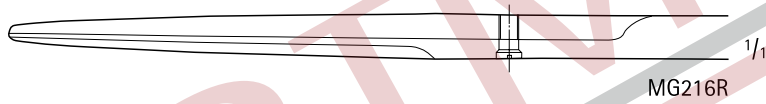



BC930R-BC931R

1/2

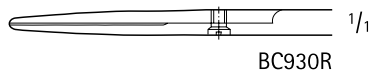

BC930R

1/1



BC931R

1/1

**Baby METZENBAUM SuperCut
Scissors, Delicate**

Catalog Number	Tip	Blade	Length (in.)
BC930R	B/B	STR	4 1/2
BC931R	B/B	CVD	4 1/2

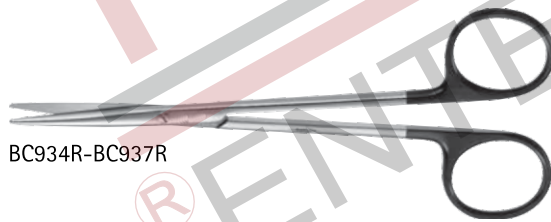

BC934R-BC937R

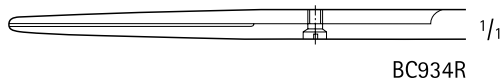

BC934R

1/1

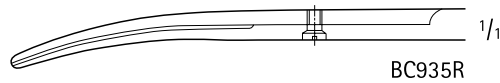

BC935R

1/1

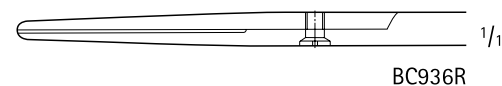

BC936R

1/1

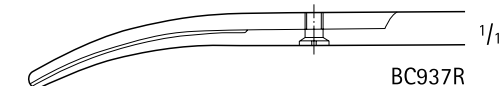

BC937R

1/1

**METZENBAUM SuperCut Scissors,
Delicate**

Catalog Number	Tip	Blade	Length (in.)
BC934R	B/B	STR	5 3/4
BC936R	B/B	STR	7
BC935R	B/B	CVD	5 3/4
BC937R	B/B	CVD	7



BC945R-BC953R

**METZENBAUM SuperCut Scissors,
Delicate**

Catalog Number	Tip	Blade	Length (in.)
BC945R	B/B	CVD	9
BC947R	B/B	CVD	10 1/4
BC949R	B/B	CVD	11 1/4
BC951R	B/B	CVD	11 3/4
BC953R	B/B	CVD	14



BC945R



BC947R

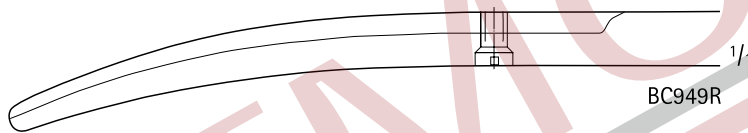

BC949R

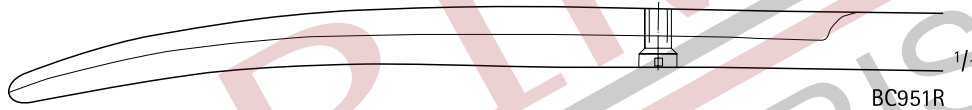

BC951R



BC953R



BC957R-BC959R

POTTS-SMITH SuperCut Scissors

Catalog Number	Tip	Blade Angle	Blade Size (mm)	Length (in.)
BC957R	B/B	25°	22	7 1/2
BC958R	B/B	45°	20	7 1/4
BC959R	B/B	60°	19	7



BC957R



BC958R



BC959R

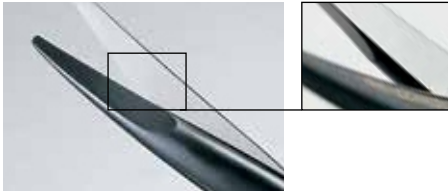

Microtome Edge

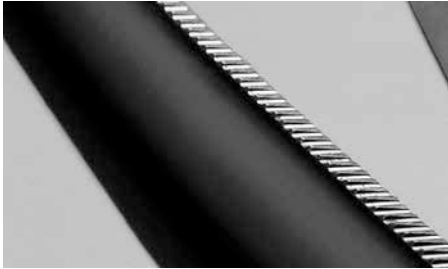

Wavecut

Noir Supreme Cut Scissors

- **Noir**
The combination of the renowned Aesculap Tungsten Carbide technology with the Aesculap Noir coating results in an extremely high surface hardness and therefore high wear resistance in daily hospital use.
- **Microtome edge**
The extremely sharp cutting edge of the scissors blade facilitates gentle cutting of tissue with minimal use of force.
- **Wavecut prevents tissue from slipping out during the cutting process.**
- **The WB after the item number indicates the Noir scissors are the wavecut style, e.g. BC211WB.**

For more information about Noir Supreme Cut Scissors see our brochure number **DOC637**.

Noir MAYO Dissecting Scissors

Catalog Number	Tip	Blade	Length (in.)
BC252B	B/B	STR	6 3/4
BC253B	B/B	CVD	6 3/4
BC253WB	B/B	CVD	6 3/4



BC252B-BC253WB



BC252B



BC253B, BC253WB

Noir MAYO-LEXER Dissecting Scissors

Catalog Number	Tip	Blade	Length (in.)
BC284B	B/B	CVD	6 1/2
BC284WB	B/B	CVD	6 1/2



BC284B-BC284WB

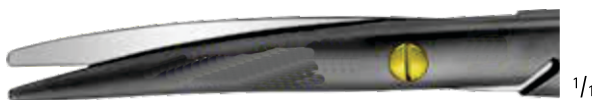

BC284B-BC284WB



BC283B-BC283WB



BC283B-BC283WB

Noir LEXER Dissecting Scissors

Catalog Number	Tip	Blade	Length (in.)
BC283B	B/B	DEL, CVD	6 1/2
BC283WB	B/B	DEL, CVD	6 1/2



BC210B-BC211WB



BC210B



BC211B, BC211WB

Noir Iris Dissecting Scissors

Catalog Number	Tip	Blade	Length (in.)
BC210B	S/S	STR	4 1/4
BC211B	S/S	CVD	4 1/4
BC211WB	S/S	CVD	4 1/4



BC273B-BC273WB



BC273B-BC273WB

Noir TOENNIS-ADSON Dissecting Scissors

Catalog Number	Tip	Blade	Length (in.)
BC273B	B/B	DEL, CVD	6 7/8
BC273WB	B/B	DEL, CVD	6 7/8



BC261B-BC277WB



BC261B, BC261WB



BC263B, BC263WB



BC271B, BC271WB



BC265B, BC265WB



BC275B, BC275WB



BC267B, BC267WB



BC277B, BC277WB

Noir METZENBAUM Dissecting Scissors

Catalog Number	Tip	Blade	Length (in.)
BC261B	B/B	CVD	5 3/4
BC261WB	B/B	CVD	5 3/4
BC263B	B/B	CVD	7
BC263WB	B/B	CVD	7
BC271B	B/B	DEL, CVD	7
BC271WB	B/B	DEL, CVD	7
BC265B	B/B	CVD	7 7/8
BC265WB	B/B	CVD	7 7/8
BC275B	B/B	DEL, CVD	7 7/8
BC275WB	B/B	DEL, CVD	7 7/8
BC267B	B/B	CVD	9
BC267WB	B/B	CVD	9
BC277B	B/B	DEL, CVD	9
BC277WB	B/B	DEL, CVD	9

**Noir NELSON-METZENBAUM
Dissecting Scissors**

Catalog Number	Tip	Blade	Length (in.)
BC279B	B/B	DEL, CVD	10 1/4
BC279WB	B/B	DEL, CVD	10 1/4
BC281B	B/B	DEL, CVD	11
BC281WB	B/B	DEL, CVD	11



BC279B-BC281WB



BC279B, BC279WB



BC281B, BC281WB

CONVERSE Needle Holder

Catalog Number	Jaw	Length (in.)
BM200R	LONG SERR	5 1/8



BM200R

1/2

1/1

BM200R

HALSEY Needle Holder

Catalog Number	Tip	Jaw	Length (in.)
BM201R	DEL	SMOOTH	5 1/8
BM205R	DEL	X-SERR	5 1/8

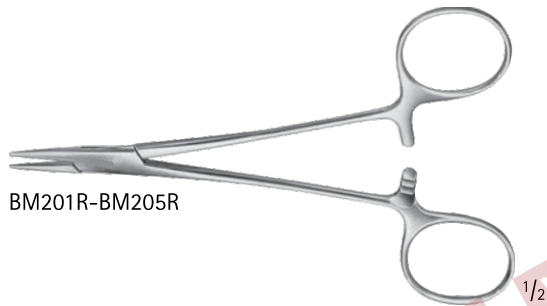

BM201R-BM205R

1/2



BM201R



BM205R

WEBSTER Needle Holder

Catalog Number	Jaw	Length (in.)
BM202R	SMOOTH	5



BM202R

1/2



BM202R

DERF Needle Holder

Catalog Number	Jaw	Length (in.)
BM204R	SERR	5



BM204R

1/2



BM204R



BM210R



BM210R

DOYEN Needle Holder

Catalog Number	Jaw	Length (in.)
BM210R	X-SERR	5

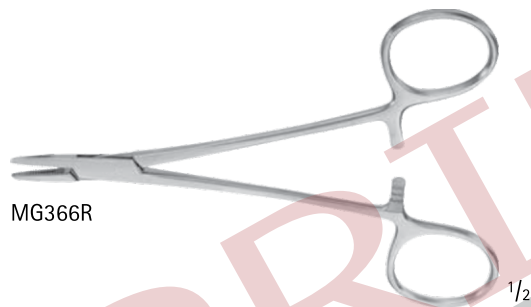

MG366R



MG366R

COLLIER Needle Holder, Fenestrated

Catalog Number	Jaw	Length (in.)
MG366R	SERR	5



BM215R, MG072R



MG072R



BM215R

BAUMGARTNER Needle Holder

Catalog Number	Jaw	Length (in.)
MG072R	SERR, GROOVED	5 1/4
BM215R	X-SERR	5 3/4

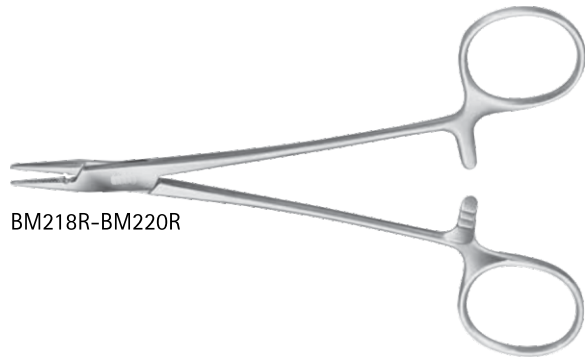

BM218R-BM220R



BM218R



BM220R

CRILE-WOOD Needle Holder

Catalog Number	Jaw	Length (in.)
BM218R	X-SERR	6
BM220R	X-SERR	6 1/4



BM219R



BM219R

CRILE-MURRAY Needle Holder

Catalog Number	Jaw	Length (in.)
BM219R	SERR	6

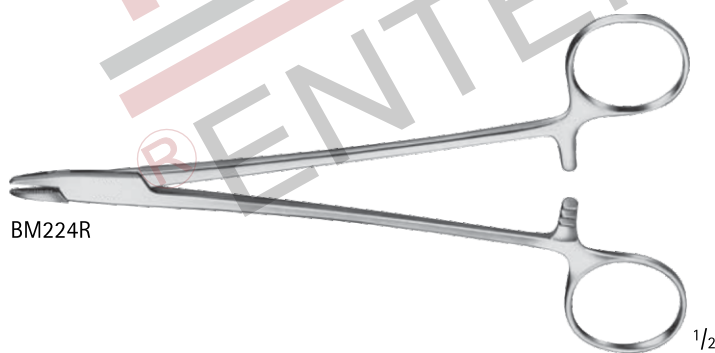

BM224R



BM224R



1/1

ADSON Needle Holder, Fenestrated

Catalog Number	Jaw	Length (in.)
BM224R	SERR	7

MAYO-HEGAR Needle Holder

Catalog Number	Jaw	Length (in.)
BM235R	X-SERR	6
BM236R	X-SERR	7 1/4
BM237R	X-SERR	7 7/8

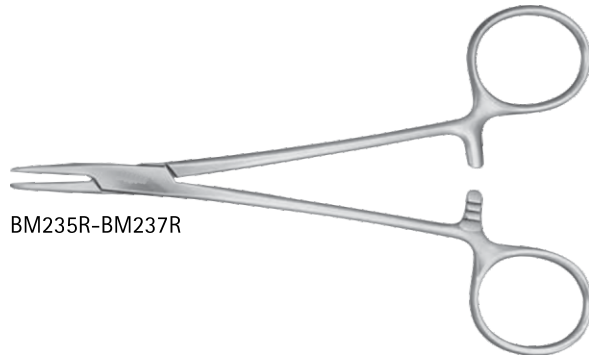

BM235R-BM237R

1/1
BM235R

1/1
BM236R

1/1
BM237R

HEGAR Needle Holder

Catalog Number	Tip	Jaw	Length (in.)
BM245R	HEAVY	X-SERR	6
BM247R	HEAVY	X-SERR	6 7/8
BM249R	HEAVY	X-SERR	8
BM255R	HEAVY	X-SERR	8

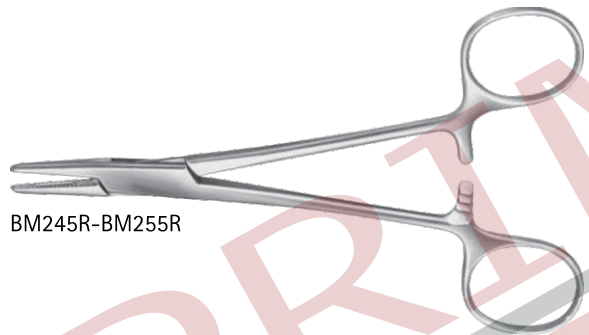

BM245R-BM255R

1/1
BM245R

1/1
BM247R

1/1
BM249R

1/1
BM255R

HEANEY Needle Holder

Catalog Number	Tip	Jaw	Length (in.)
BM259R	CVD	SERR	7 7/8



BM259R

1/1
BM259R

JAMESON Needle Holder

Catalog Number	Tip	Jaw	Length (in.)
BM270R	DEL	X-SERR	9

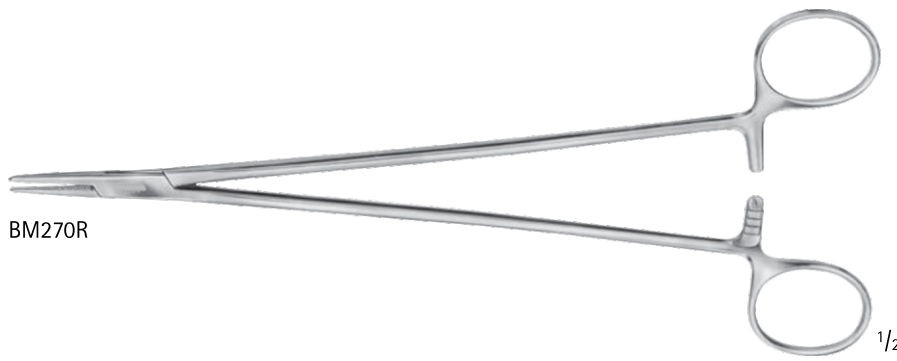

BM270R

^{1/1}
BM270R

WANGENSTEEN Needle Holder

Catalog Number	Jaw	Length (in.)
BM272R	X-SERR	10 3/4

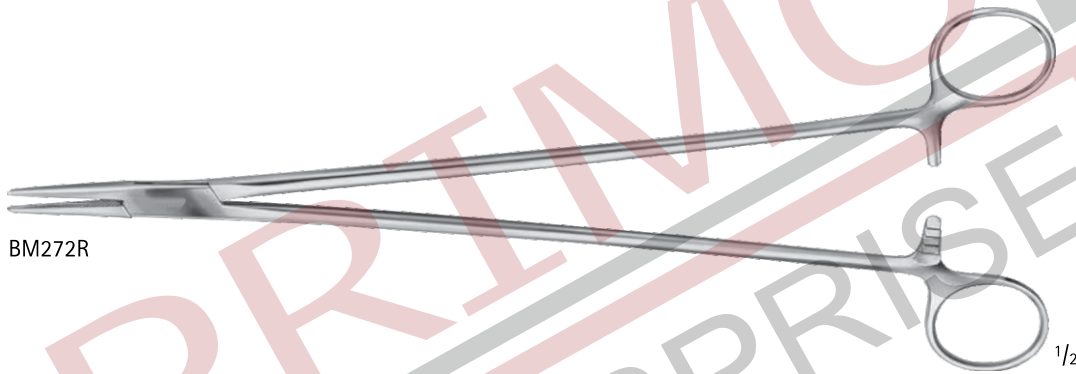

BM272R

^{1/1}
BM272R

MASSON Needle Holder

Catalog Number	Jaw	Length (in.)
BM275R	X-SERR	10 1/2

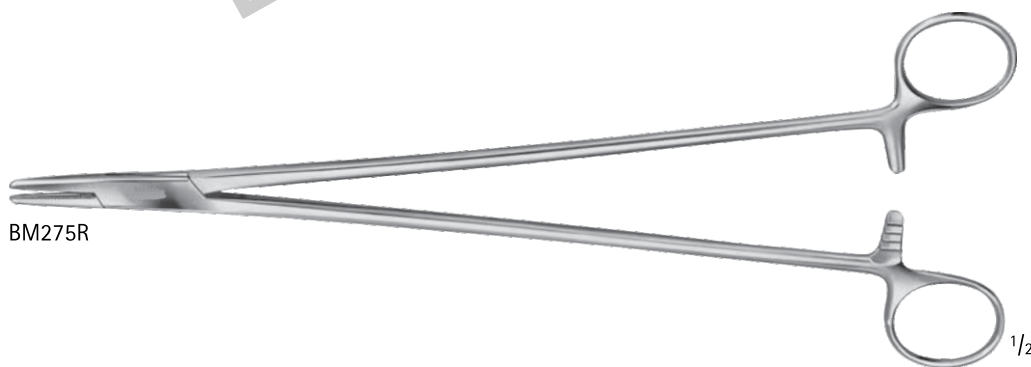

BM275R

^{1/1}
BM275R

HEGAR-OLSEN Needle Holder/Scissors

Catalog Number	Jaw	Length (in.)
BM290R	SERR	5 1/2
BM291R	SERR	7 1/4

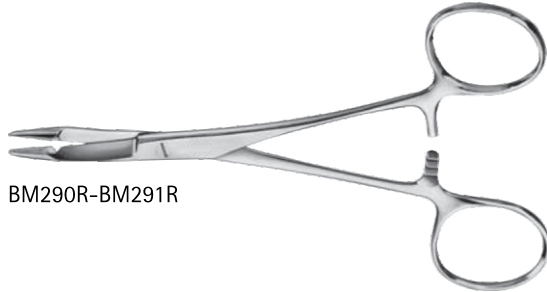

BM290R-BM291R

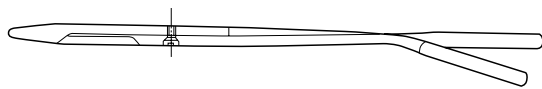

1/1
BM290R

1/1
BM291R

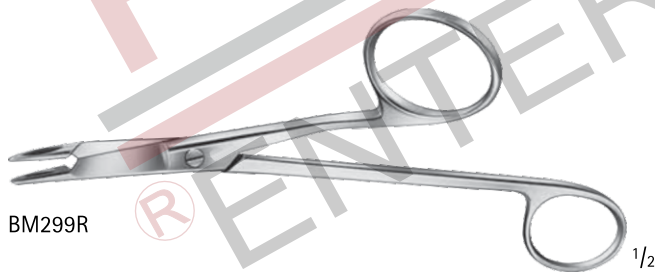

BM299R

GILLIES Needle Holder/Scissors

Catalog Number	Jaw	Length (in.)
BM299R	SERR	6 1/4

1/2

1/1
BM299R

Aesculap features Needle Holders with Tungsten Carbide (TC) inserts. A smooth jaw and three different serration patterns are available, depending on the size of the suture needle.

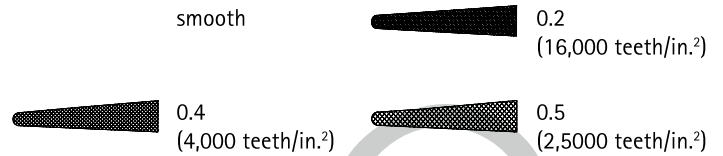

We recommend carbide inserts as follows:

Jaw Surface	Suture Material
Smooth	9/0 - 11/0
0.2 mm pitch of serration	6/0 - 10/0
0.4 mm pitch of serration	4/0 - 6/0
0.5 mm pitch of serration	up to 3/0



BM008R

DUROGRIP TC DERF Needle Holder

Catalog Number	Jaw	Length (in.)
BM008R	SERR	4 3/4

DUROGRIP TC MASING Needle Holder

Catalog Number	Jaw	Length (in.)
BM009R	SERR	5 1/8



BM009R

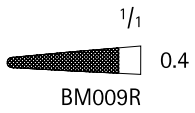

DUROGRIP TC HALSEY Needle Holder

Catalog Number	Jaw	Length (in.)
BM010R	SMOOTH	4 3/4
BM012R	SERR	5 1/8



BM010R



BM012R

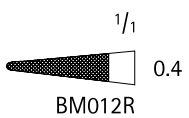

DUROGRIP TC CONVERSE Needle Holder

Catalog Number	Jaw	Length (in.)
BM011R	SERR	5 1/8

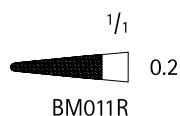

DUROGRIP TC WEBSTER Needle Holder

Catalog Number	Jaw	Length (in.)
BM014R	SMOOTH	5 1/8
BM024R	SERR	5 1/8



DUROGRIP TC BAUMGARTNER Needle Holder

Catalog Number	Jaw	Length (in.)
BM015R	SERR	5 3/4

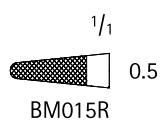

DUROGRIP TC NEW ORLEANS Needle Holder

Catalog Number	Jaw	Length (in.)
MG522R	SERR	7

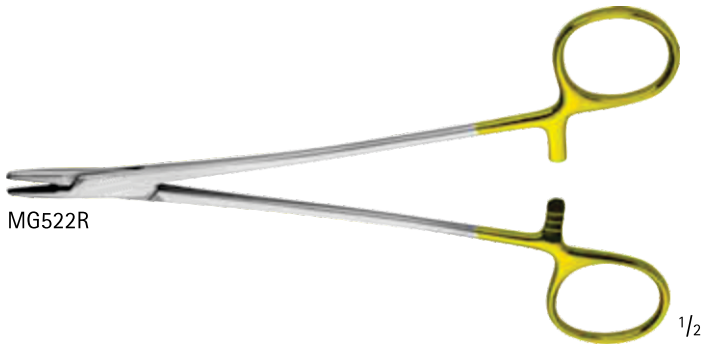

MG522R



MG522R

DUROGRIP TC SAROT Needle Holder

Catalog Number	Jaw	Length (in.)
BM020R	SERR	7
BM023R	SERR	10 1/4

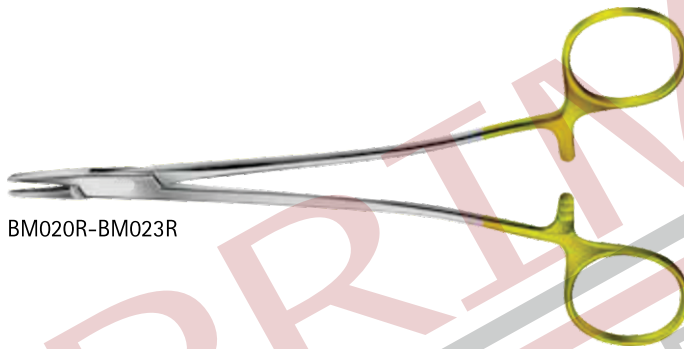

BM020R-BM023R

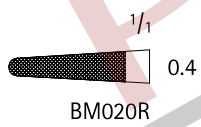

BM020R

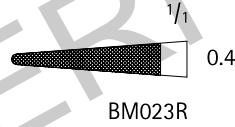

BM023R

DUROGRIP TC Baby CRILE-WOOD Needle Holder

Catalog Number	Jaw	Length (in.)
BM013R	SERR	6



BM013R

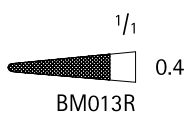

BM013R



BM016R, BM021R, MB604R

DUROGRIP TC CRILE-WOOD Needle Holder

Catalog Number	Jaw	Length (in.)
BM016R	SERR	5 3/4
BM017R	SERR	7 1/4
BM019R	SERR	7 7/8
BM030R	SERR	10 5/8
BM021R	SERR	12
MB604R	SERR	14
BM029R	SMOOTH	6

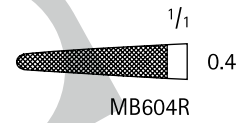
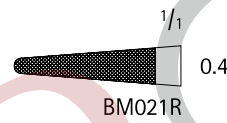
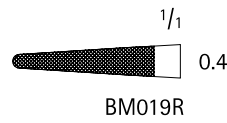
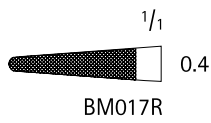
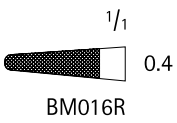

BM030R

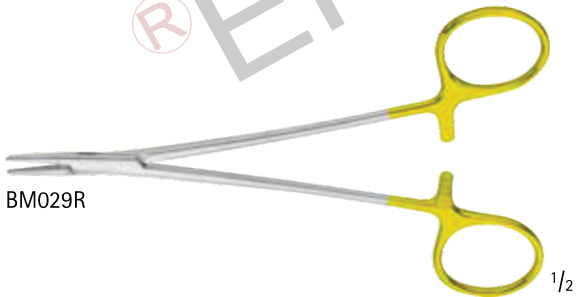
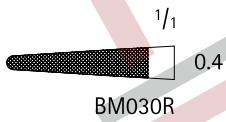

BM029R

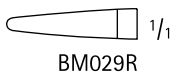

**DUROGRIP TC MAYO-HEGAR-SEELEY
Needle Holder**

Catalog Number	Jaw	Length (in.)
BM022R	SERR	8

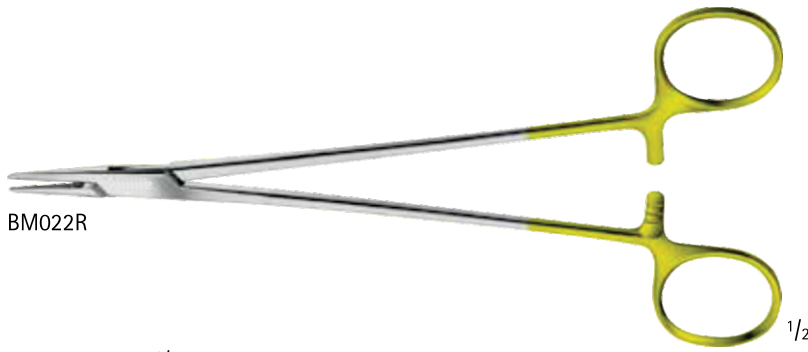

BM022R

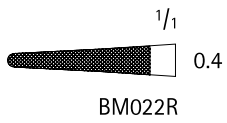

BM022R

DUROGRIP TC Fine Needle Holder

Catalog Number	Tip	Jaw	Length (in.)
BM025R	X-DEL	SERR	7
BM026R	X-DEL	SERR	7 7/8
BM027R	X-DEL	SERR	9

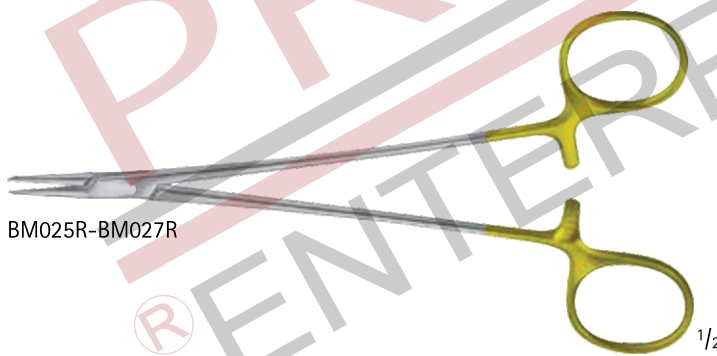

BM025R-BM027R

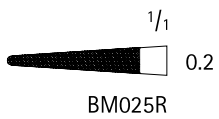

BM025R

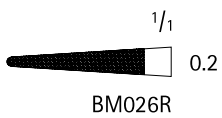

BM026R

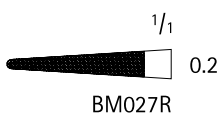

BM027R

DUROGRIP TC DEBAKEY Needle Holder

Catalog Number	Tip	Jaw	Length (in.)
BM032R	DEL	SERR	6
BM033R	DEL	SERR	6 1/2
BM035R	DEL	SERR	7
BM034R	DEL	SERR	8 1/4
BM036R	DEL	SERR	9
BM037R	DEL	SERR	10 1/4
BM038R	DEL	SERR	12
BM063R	X-DEL	SERR	6 1/2
BM064R	X-DEL	SERR	8 1/4
BM040R	X-DEL	SERR	12



BM032R

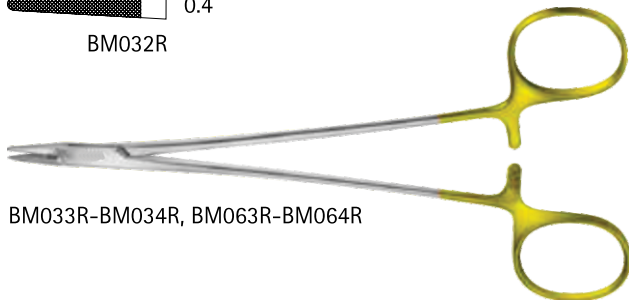
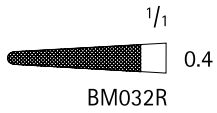

BM033R-BM034R, BM063R-BM064R

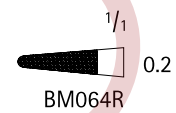
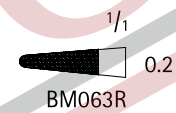
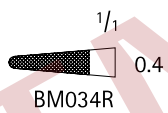
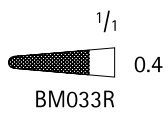

BM035R-BM038R

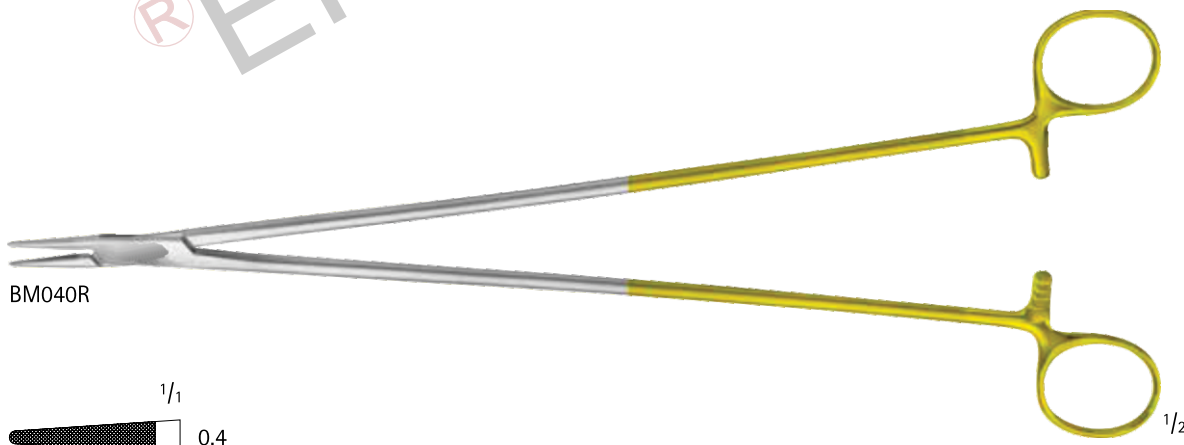
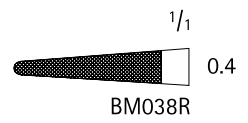
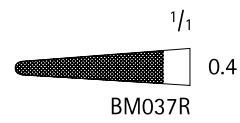
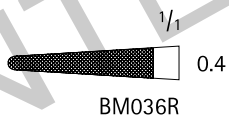
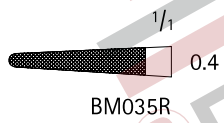

BM040R

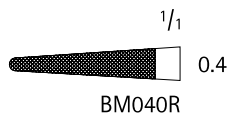

GENERAL SURGERY DUROGRIP TC NEEDLE HOLDER

DUROGRIP TC RYDER Needle Holder

Catalog Number	Tip	Jaw	Length (in.)
BM054R	X-DEL	SERR	5 1/4
BM055R	X-DEL	SERR	6 1/8
BM056R	X-DEL	SERR	6 7/8
BM057R	X-DEL	SERR	8 1/4
BM058R	X-DEL	SERR	9
BM044R	DEL	SERR	5 1/4
BM045R	DEL	SERR	6 7/8
BM046R	DEL	SERR	7 3/4
BM047R	DEL	SERR	10 1/2
BM074R	DEL	SMOOTH	6
BM075R	DEL	SMOOTH	7
BM076R	DEL	SMOOTH	8 7/8

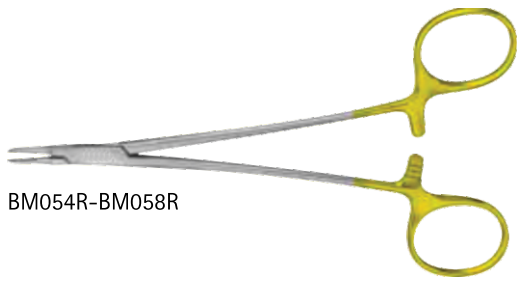

BM054R-BM058R

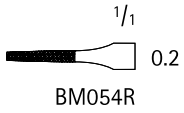

BM054R

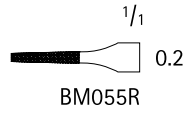

BM055R

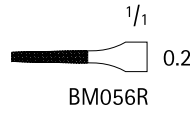

BM056R

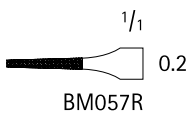

BM057R

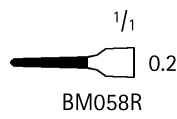

BM058R

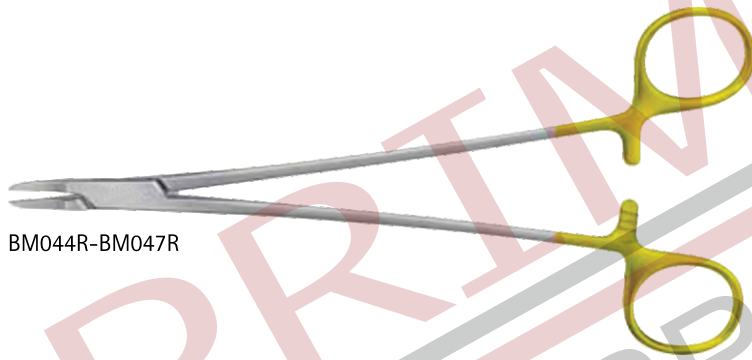

BM044R-BM047R

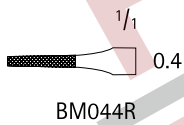

BM044R

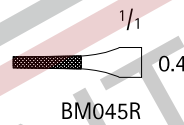

BM045R

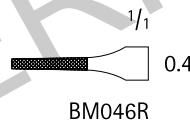

BM046R

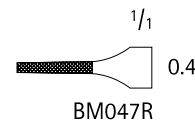

BM047R

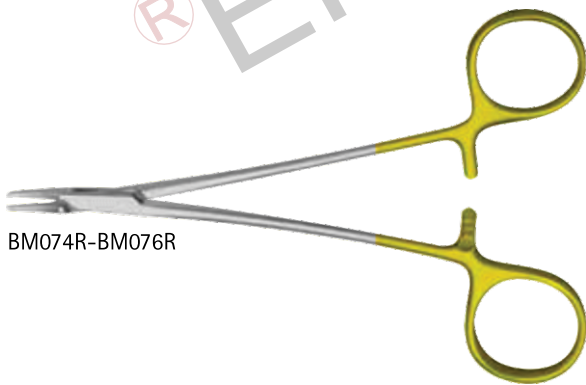

BM074R-BM076R



BM074R

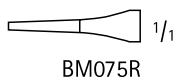

BM075R

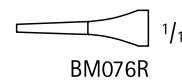

BM076R



MB606R-MB612R

DUROGRIP TC FRENCH Eye Needle Holder

Catalog Number	Jaw	Length (in.)
MB606R	SERR	6 1/4
MB607R	SERR	7 1/4
MB611R	SERR	8
MB612R	SERR	9 1/4

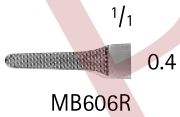

MB606R

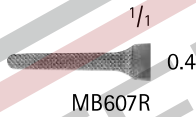

MB607R

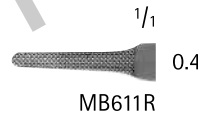

MB611R

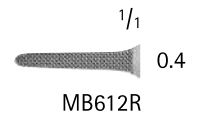

MB612R

DUROGRIP TC MAYO-HEGAR Needle Holder

Catalog Number	Jaw	Length (in.)
BM065R	SERR	6
BM066R	SERR	7 1/4
BM067R	SERR	8
BM068R	SERR	9 1/4
BM070R	SERR	10 1/2
BM069R	SERR	12
MB617R	SERR	14



BM065R-BM070R

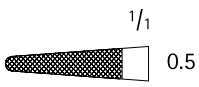

BM065R

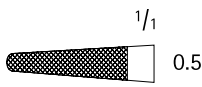

BM066R

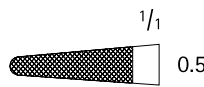

BM067R

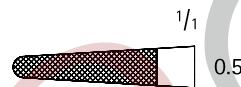

BM068R

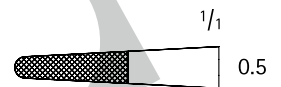

BM070R



BM069R

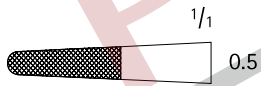

BM069R

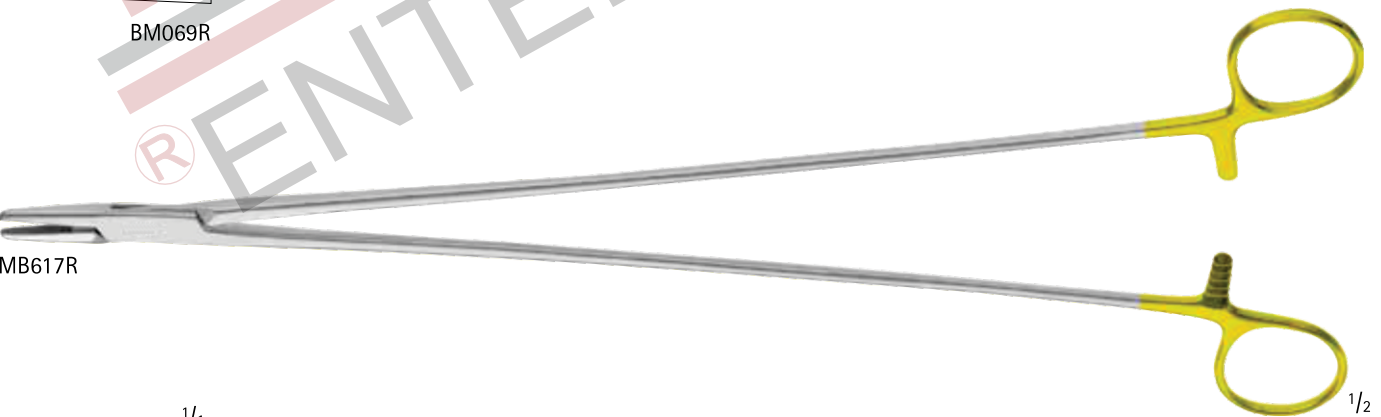

MB617R



MB617R

DUROGRIP TC HEGAR Needle Holder

Catalog Number	Tip	Jaw	Length (in.)
BM077R	HEAVY	SERR	8
BM078R	HEAVY	SERR	9 1/2

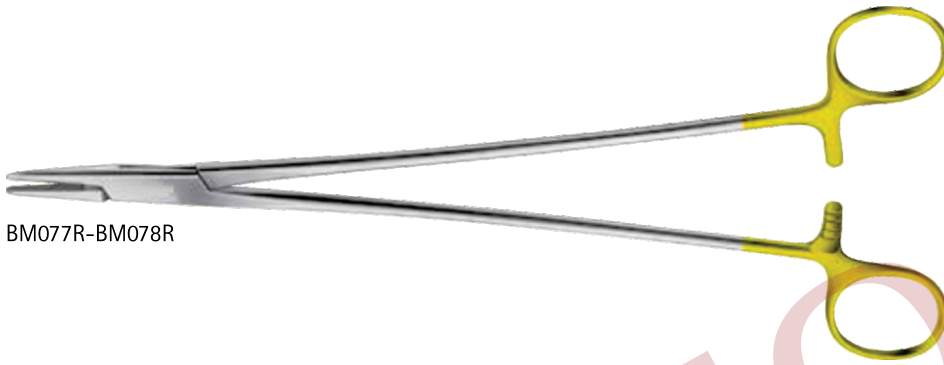

BM077R-BM078R

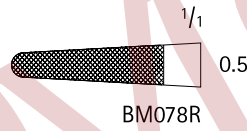
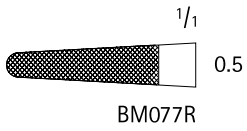

DUROGRIP TC WANGENSTEEN Needle Holder

Catalog Number	Jaw	Length (in.)
BM042R	SERR	10 3/4

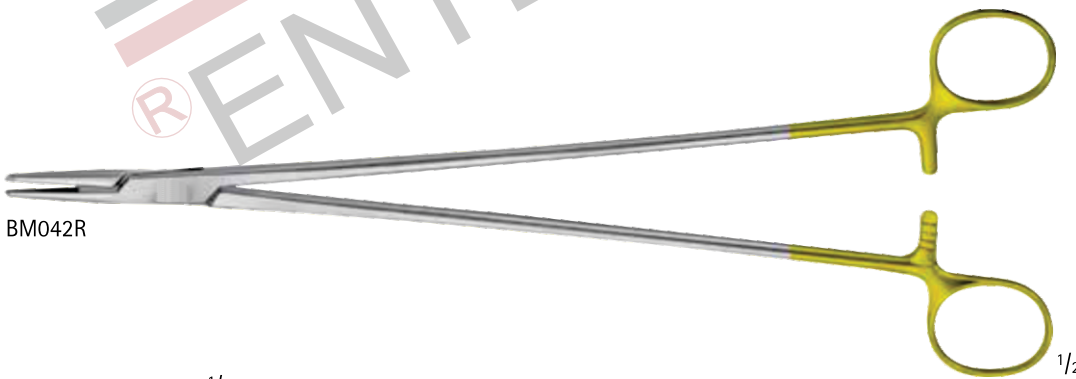

BM042R

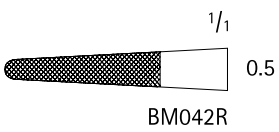

DUROGRIP TC MASSON Needle Holder

Catalog Number	Jaw	Length (in.)
BM090R	SERR	10 1/2



BM090R

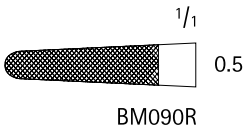

BM090R

DUROGRIP TC MAYO-MASSON Needle Holder

Catalog Number	Jaw	Length (in.)
MB918R	SERR	16



MB918R

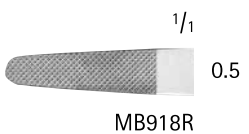

MB918R

DUROGRIP TC HEANEY Needle Holder

Catalog Number	Tip	Jaw	Length (in.)
BM081R	CVD	SERR	7 7/8
BM084R	CVD	SERR	10 1/4

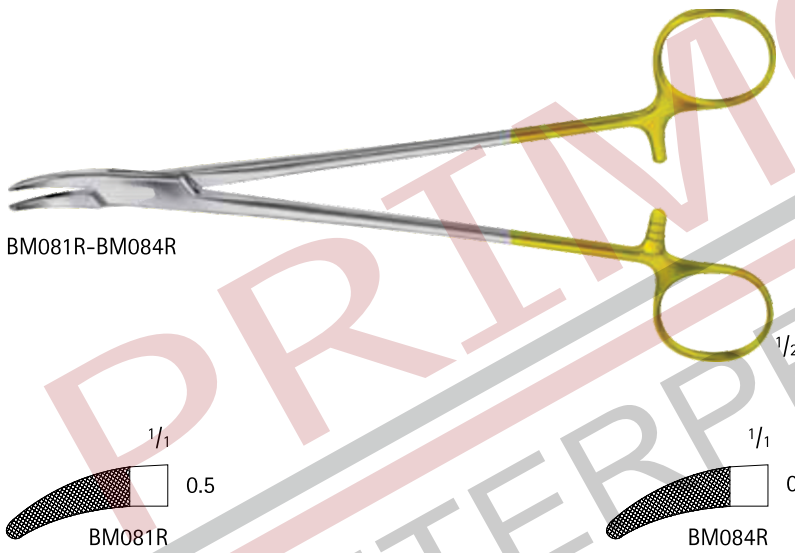

DUROGRIP TC FINOCHIETTO Needle Holder

Catalog Number	Tip	Jaw	Length (in.)
BM092R	ANG	SERR	10 1/2

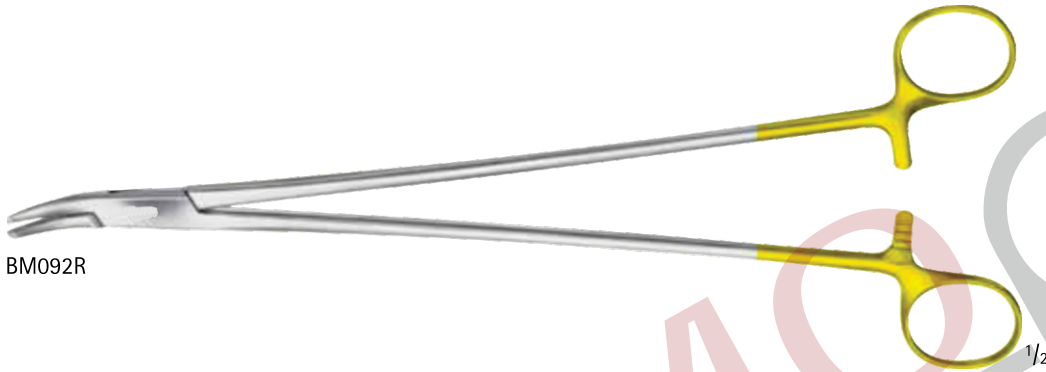

BM092R

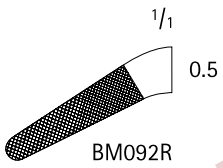

BM092R

DUROGRIP TC STRATTE Needle Holder

Catalog Number	Tip	Jaw	Length (in.)
BM095R	CVD	SERR	8 1/4
BM096R	CVD	SERR	9

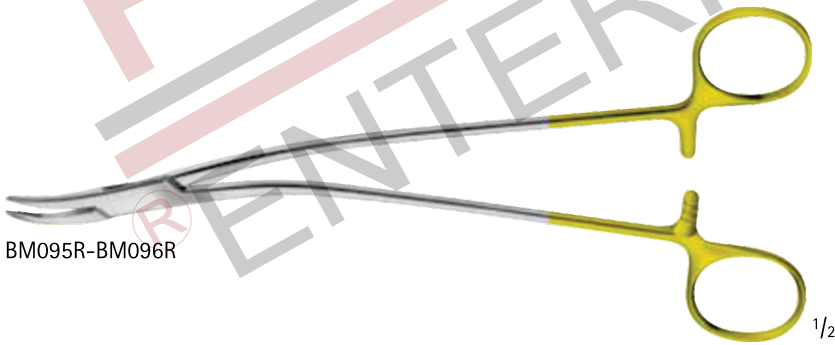

BM095R-BM096R

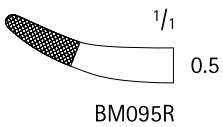

BM095R

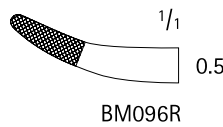

BM096R

DUROGRIP TC Wire Twister

Catalog Number	Tip	Jaw	Length (in.)
BM110R	ROUND	SERR	6 1/8
BM111R	SQUARE	SERR	6

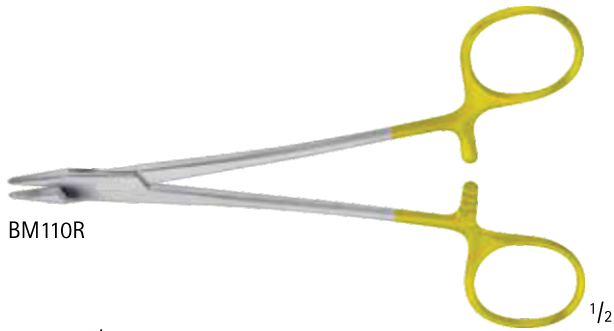

BM110R

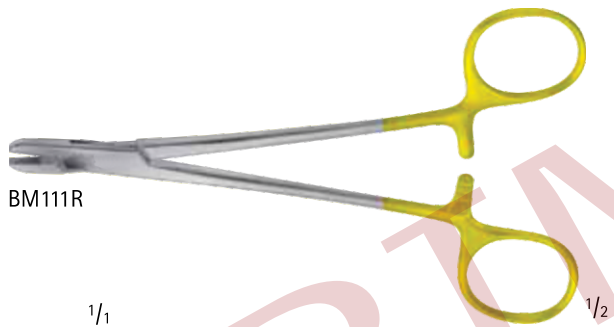
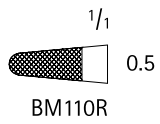

BM111R

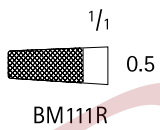

DUROGRIP TC BAUMGARTNER Wire Twister

Catalog Number	Tip	Jaw	Length (in.)
BM112R	SQUARE	SERR	7 7/8

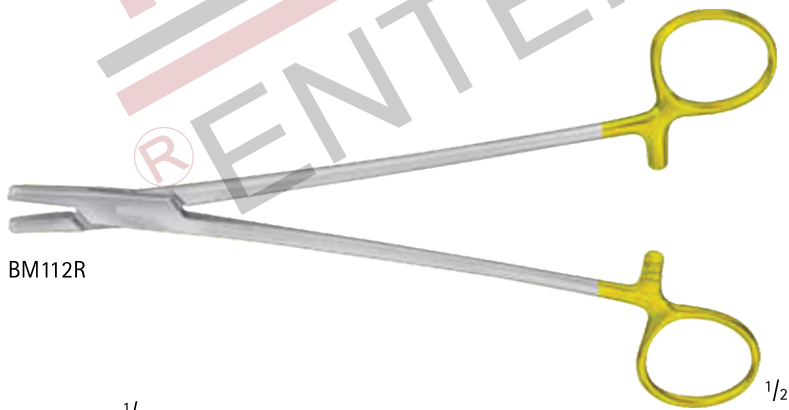

BM112R

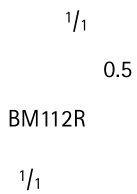

**DUROGRIP TC BERRY Sternal Wire
Twister**

Catalog Number	Tip	Jaw	Length (in.)
MD456R	ROUND	SERR	7 1/4



MD456R

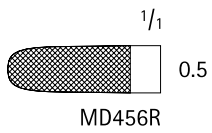

DUROGRIP TC RUBIO Wire Twister

Catalog Number	Tip	Jaw	Length (in.)
MB550R	ROUND	SERR	5



MB550R

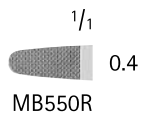



BM149R-BM154R

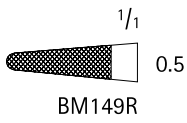

BM149R

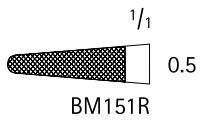

BM151R

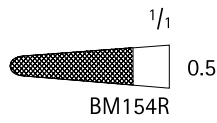

BM154R

DUROGRIP TC MATHIEU Needle Holder

Catalog Number	Jaw	Length (in.)
BM149R	SERR	5 1/2
BM151R	SERR	6 1/2
BM154R	SERR	7 7/8

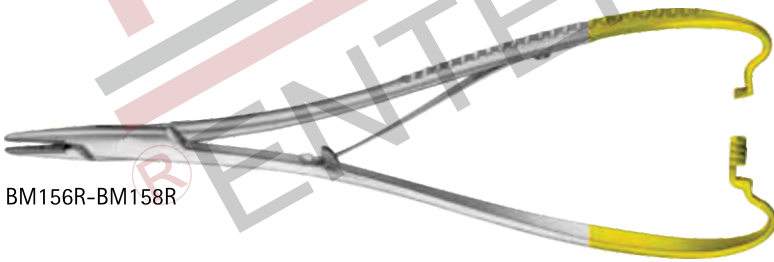

BM156R-BM158R

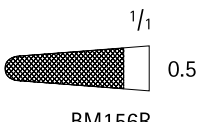

BM156R

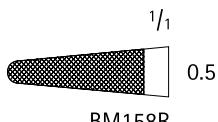

BM158R

DUROGRIP TC MATHIEU Needle Holder, Heavy

Catalog Number	Jaw	Length (in.)
BM156R	SERR	7 7/8
BM158R	SERR	9 5/8



BM822R-BM824R

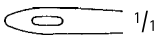

1/16

BM822R

1/16

1/16

BM824R



BM749R, BM781R, BM807R, BM809R,
BM811R, BM813R

1/2

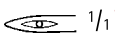

1/16

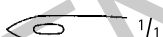

1/16

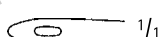

1/16

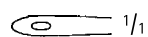

1/16

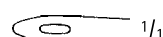

1/16

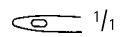

1/16

BM781R

BM813R

BM749R

BM809R

BM807R

BM811R

DESCHAMPS Needle

Catalog Number	Hand Orientation	Tip	Length (in.)
BM822R	RIGHT	BLUNT, 3.5 MM	9 1/2
BM824R	RIGHT	BLUNT, 5 MM	11
BM781R	LEFT	SHARP, 2 MM	8 1/4
BM749R	LEFT	SHARP, 3.5 MM	8 1/2
BM809R	LEFT	BLUNT, 2.5 MM	8 1/4
BM807R	LEFT	BLUNT, 2.5 MM	8 1/2
BM811R	LEFT	BLUNT, 3.5 MM	8 1/2
BM813R	LEFT	STEEP, BLUNT, 2 MM	8 7/8



HURD Needle

Catalog Number	Hand Orientation	Tip	Length (in.)
BM770R	RIGHT	SHARP	8 1/4
BM771R	LEFT	SHARP	8 1/4

BM770R



BM771R



KRONECKER Needle

Catalog Number	Hand Orientation	Tip	Length (in.)
BM801R	RIGHT	BLUNT	6 1/8
BM802R	LEFT	BLUNT	6 1/8

BM801R



BM802R



SYME Suture Needle

Catalog Number	Tip	Length (in.)
BM855R	BLUNT	6 3/4

BM855R



BD043R-BD053R

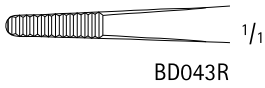

BD043R

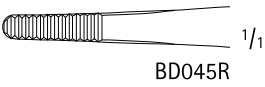

BD045R

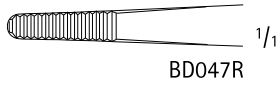

BD047R

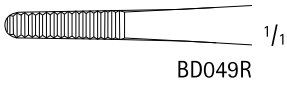

BD049R

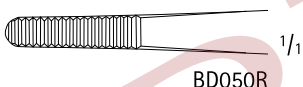

BD050R

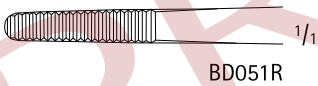

BD051R

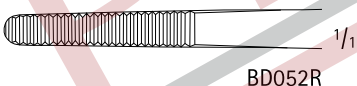

BD052R

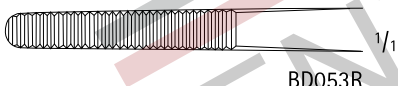

BD053R



BD077R

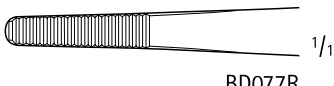

BD077R

Dressing Forceps, Standard Patterns

Catalog Number	Tip	Length (in.)
BD043R	SERR	4 1/2
BD045R	SERR	5 1/8
BD047R	SERR	5 3/4
BD049R	SERR	6 1/4
BD050R	SERR	7
BD051R	SERR	7 7/8
BD052R	SERR	9 3/4
BD053R	SERR	11 3/4

Dressing Forceps, Extra Wide

Catalog Number	Tip	Length (in.)
BD077R	SERR	5 3/4



BD023R-BD033R

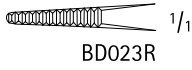

BD023R $\frac{1}{1}$

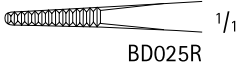

BD025R $\frac{1}{1}$



BD027R $\frac{1}{1}$



BD029R $\frac{1}{1}$

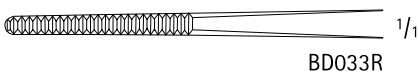

BD033R $\frac{1}{1}$



BD035R-BD037R

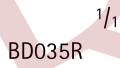

BD035R $\frac{1}{1}$



BD037R $\frac{1}{1}$



BD210R $\frac{1}{2}$

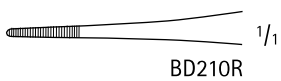

BD210R $\frac{1}{1}$

Dressing Forceps, Delicate

Catalog Number	Tip	Length (in.)
BD023R	STR, SERR	4 1/2
BD025R	STR, SERR	5 1/8
BD027R	STR, SERR	5 3/4
BD029R	STR, SERR	6 1/4
BD033R	STR, SERR	12
BD035R	CVD, SERR	5 1/8
BD037R	CVD, SERR	5 1/2

Dressing Forceps, Extra Delicate

Catalog Number	Tip	Length (in.)
BD210R	SERR	4 1/2

Tissue Forceps, Delicate

Catalog Number	Tip	Teeth	Length (in.)
BD533R	STR	1 x 2	4 1/2
BD535R	STR	1 x 2	5 1/8
BD537R	STR	1 x 2	5 3/4
BD539R	STR	1 x 2	6 1/4
BD540R	STR	1 x 2	7
BD541R	STR	1 x 2	7 7/8
BD542R	STR	1 x 2	9 3/4
BD543R	STR	1 x 2	11 3/4
MB803R	STR	2 x 3	4 1/2
BD575R	STR	2 x 3	5 1/8
BD577R	STR	2 x 3	5 3/4
BD579R	STR	2 x 3	6 1/4
BD580R	STR	2 x 3	7
BD581R	STR	2 x 3	7 7/8
BD587R	STR	3 x 4	5 3/4
BD589R	STR	3 x 4	6 1/4
BD591R	STR	3 x 4	7 7/8
BD527R	CVD	1 x 2	5 3/4



BD533R-BD543R

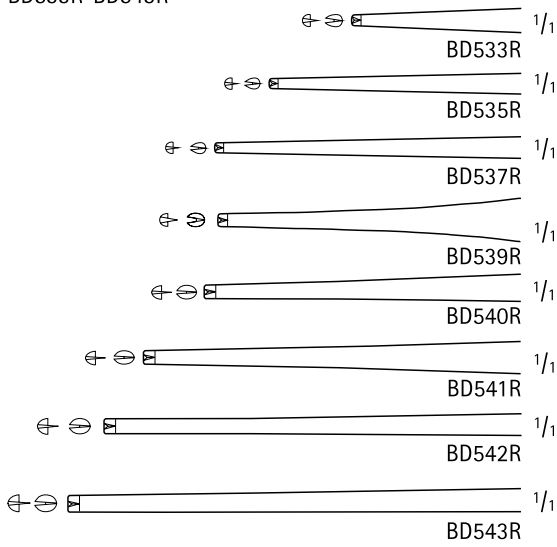

MB803R

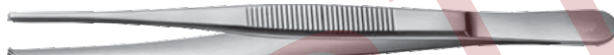
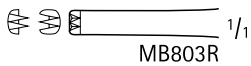

BD575R-BD581R

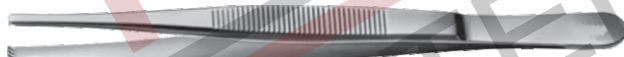
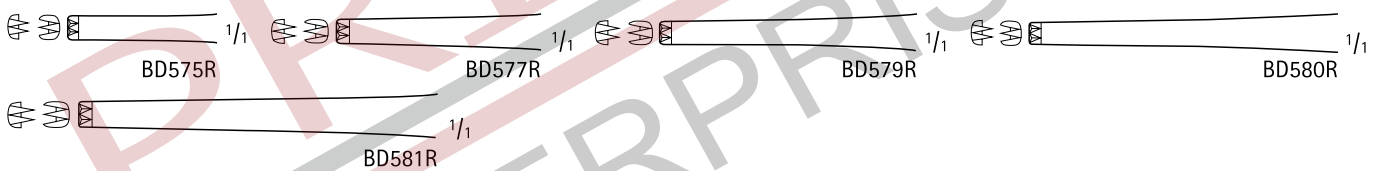

BD587R-BD591R



BD527R



BD547R-BD549R

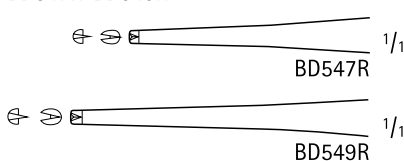

Tissue Forceps, Medium

Catalog Number	Teeth	Length (in.)
BD547R	1 x 2	5 3/4
BD549R	1 x 2	6 1/4



BD553R-BD563R

Tissue Forceps, Standard Patterns

Catalog Number	Teeth	Length (in.)
BD553R	1 x 2	4 1/2
BD555R	1 x 2	5 1/8
BD557R	1 x 2	5 3/4
BD559R	1 x 2	6 1/4
BD560R	1 x 2	7
BD561R	1 x 2	7 7/8
BD562R	1 x 2	9 3/4
BD563R	1 x 2	11 3/4

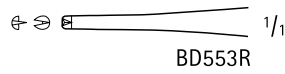

BD553R



BD555R



BD557R



BD559R



BD560R



BD561R



BD562R

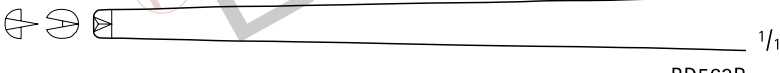

BD563R



BD690R-BD692R

$\frac{1}{1}$
BD690R

$\frac{1}{1}$
BD692R

STRASSBURGER Tissue Forceps

Catalog Number	Tip	Teeth	Length (in.)
BD690R	X-SERR	1 x 2	6
BD692R	X-SERR	1 x 2	7 7/8



MG077R

CURTIS Tissue Forceps

Catalog Number	Tip	Length (in.)
MG077R	SERR	8 3/4

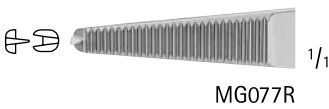

MG077R



BD693R

$\frac{1}{1}$
BD693R

BONNEY Tissue Forceps

Catalog Number	Tip	Teeth	Length (in.)
BD693R	SERR	1 x 2	6 7/8
MG357R	SERR	2 x 3	6 3/4

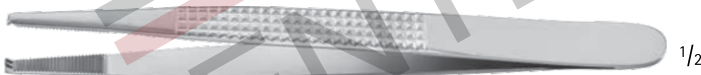

MG357R

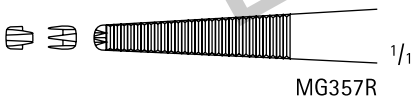

MG357R



BD733R

$\frac{1}{1}$ BD733R

MARTIN Tissue Forceps

Catalog Number	Teeth	Length (in.)
BD733R	7 x 8	6 1/8



STILLÉ-BARRAYA CV Forceps

Catalog Number	Tip	Teeth	Length (in.)
BD725R	X-SERR	3 x 4	7
BD726R	X-SERR	3 x 4	7 7/8
BD727R	X-SERR	3 x 4	9 3/4

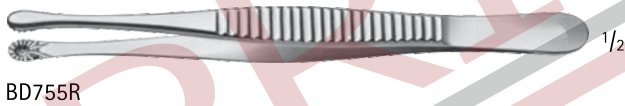
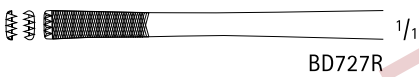

RUSSIAN Tissue Forceps

Catalog Number	Length (in.)
BD755R	6
BD760R	7 7/8
XG006R	9 3/4
BD761R	10 1/4
MB921R	12
MB922R	14

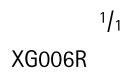
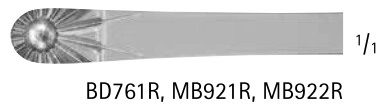



MB208R-MB923R



MAYO-RUSSIAN Tissue Forceps

Catalog Number	Tip	Length (in.)
MB208R	FENESTRATED	9
MB923R	FENESTRATED	14



BD750R

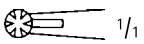

BD750R

SELMAN Tissue Forceps

Catalog Number	Length (in.)
BD750R	6 1/8
MB795R	7 7/8
MG078R	9 3/4



MB795R



MB795R



MG078R



MG078R



BD878R 1/2

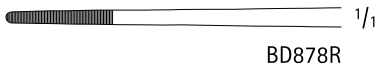

BD878R 1/1



BD879R 1/2

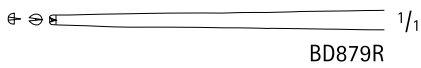

BD879R 1/1



BD883R 1/2

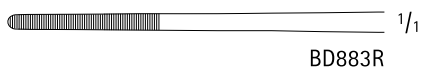

BD883R 1/1



US147 1/2



US147 1/1



MB231 1/2



MB231 1/1



MB227 1/2



MB227 1/1

LUCAE Bayonet Forceps

Catalog Number	Tip	Teeth	Length (in.)
BD878R	SERR	-	5 1/2
BD879R	SMOOTH	1 x 2	5 1/2

GRUENWALD Bayonet Forceps

Catalog Number	Tip	Length (in.)
BD883R	SERR	7 7/8

CUSHING Bayonet Forceps

Catalog Number	Tip	Teeth	Length (in.)
US147	SERR	-	7 3/4
MB231	SMOOTH	1 x 2	7 1/4

BROWN-CUSHING Bayonet Forceps

Catalog Number	Teeth	Length (in.)
MB227	7 x 7	7 1/4



BD876R, MB804R



BD876R, MB804R

BROWN-BAHNSON Bayonet Forceps

Catalog Number	Tip	Length (in.)
BD876R	SERR	6 1/8
MB804R	SERR	8



BD880R, MB236

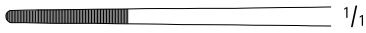

BD880R



MB236

JANSEN Bayonet Forceps

Catalog Number	Tip	Length (in.)
BD880R	SERR	6 1/4
MB236	SERR	6 1/2



BD885R



BD885R



BD886R



BD886R

Bayonet Forceps

Catalog Number	Tip	Teeth	Length (in.)
BD885R	SMOOTH	-	7 1/4
BD886R	SMOOTH	1 x 2	7 7/8



US104-US105

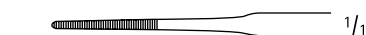

US105



US104

GERALD Bayonet Forceps

Catalog Number	Tip	Teeth	Length (in.)
US105	SERR	-	7 1/2
US104	SMOOTH	1 x 2	7 1/2

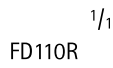

BD900R, BD902R, BD910R-BD911R

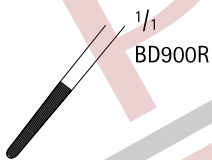

BD904R $\frac{1}{1}$

Bayonet Forceps

Catalog Number	Tip	Length (in.)
BD887R		6 1/4
FD110R	FINE	7 1/4
FD111R	BROAD	7 1/4

TROELTSCH Bayonet Forceps

Catalog Number	Tip	Length (in.)
BD900R	ANG/SERR	4
BD902R	ANG/SERR	4 1/2
BD910R	ANG/SERR	5 1/2
BD911R	ANG/SERR	6 3/4

WILDE Bayonet Forceps

Catalog Number	Tip	Length (in.)
BD904R	ANG/SERR	4 1/2



BD225R, MB291R



BD225R

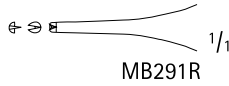

MB291R

HUDSON Forceps

Catalog Number	Tip	Teeth	Length (in.)
BD225R	SERR	-	5
MB291R	SMOOTH	1 x 2	5



BD610R-BD611R

FERRIS-SMITH Tissue Forceps

Catalog Number	Tip	Teeth	Length (in.)
BD610R	X-SERR	1 x 2	6 7/8
BD611R	X-SERR	2 x 3	6 7/8

BD610R

BD611R



BD215R-BD216R

SEMKEN Forceps, Delicate

Catalog Number	Tip	Teeth	Length (in.)
BD215R	SERR	-	5
BD216R	SERR	-	6
BD665R	SMOOTH	1 x 2	5
BD667R	SMOOTH	1 x 2	6
BD666R	SMOOTH	2 x 3	5



BD215R



BD216R



BD665R-BD667R

BD665R

BD667R

BD666R

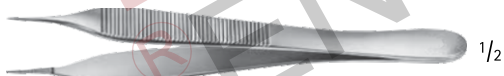

BD220R

Micro ADSON Forceps, Delicate

Catalog Number	Tip	Length (in.)
BD220R	SERR, W/ PLATFORM	4 3/4
BD223R	SERR	6

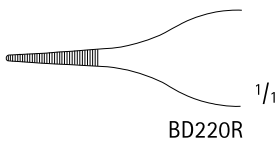

BD220R



BD223R

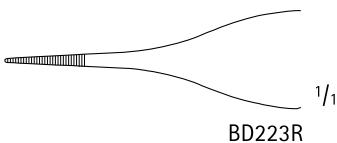

BD223R

ADSON Forceps, Delicate

Catalog Number	Tip	Teeth	Handle	Length (in.)
BD222R	SERR	-	-	4 3/4
MA156R	SERR, X-LONG	-	-	4 3/4
BD511R	SMOOTH	1 x 2	-	4 3/4
MG275R	SERR	1 x 2	-	4 3/4
BD512R	X-SERR W/ PLATFORM	1 x 2	-	4 3/4
MA536R	X-LONG	1 x 2	-	4 3/4
MB454R	SMOOTH	2 x 3	-	4 3/4
BD506R	SMOOTH	1 x 2	FENE-STRATED	4 3/4
BD507R	SMOOTH	1 x 2	FENE-STRATED	4 3/4
BD508R	SERR	1 x 2	FENE-STRATED	4 3/4
BD513R	X-SERR W/ PLATFORM	1 x 2	FENE-STRATED	4 3/4
BD521R	SMOOTH	1 x 2	FENE-STRATED	6

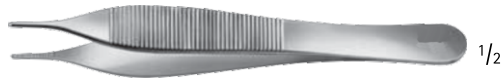

BD222R, MA156R

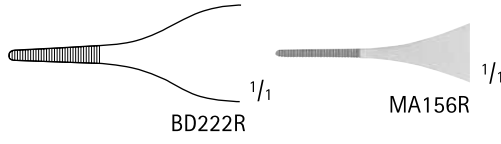

BD511R



MG275R



BD512R



MA536R

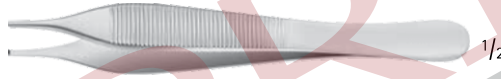

MB454R



BD506R



BD507R



BD508R



BD513R



BD521R

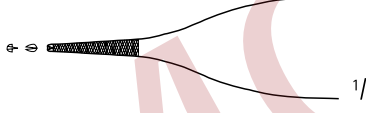
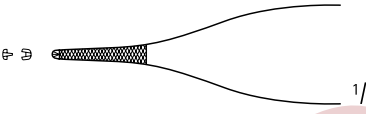
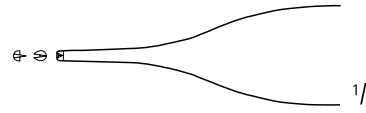

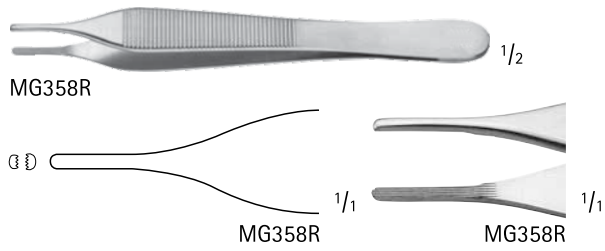

MUSTARDE Suture Removal Forceps

Catalog Number	Tip	Length (in.)
MG358R	LONGITUDINAL, SERR	5

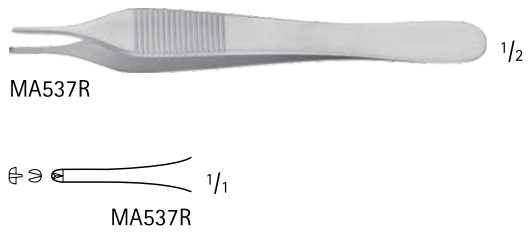

CALLISON-ADSON Tissue Forceps, W/ Platform

Catalog Number	Teeth	Length (in.)
MA537R	1 x 2	5

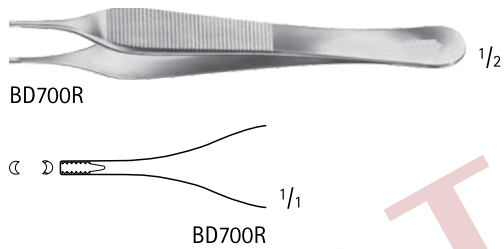

ADSON-BROWN Tissue Forceps

Catalog Number	Teeth	Length (in.)
BD700R	7 x 8	4 3/4

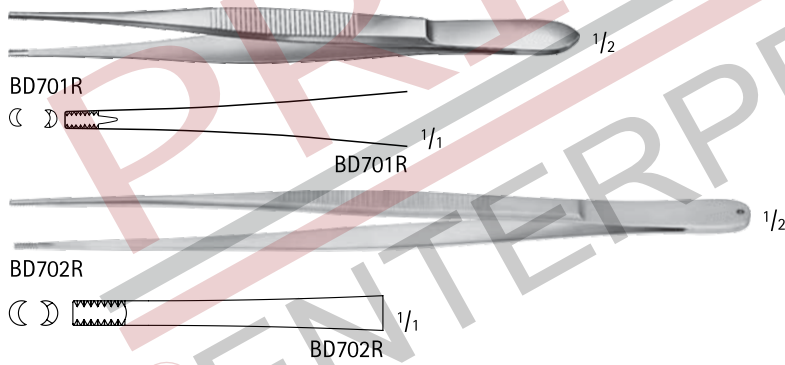

BROWN Tissue Forceps

Catalog Number	Teeth	Length (in.)
BD701R	7 x 8	6
BD702R	7 x 8	7 7/8

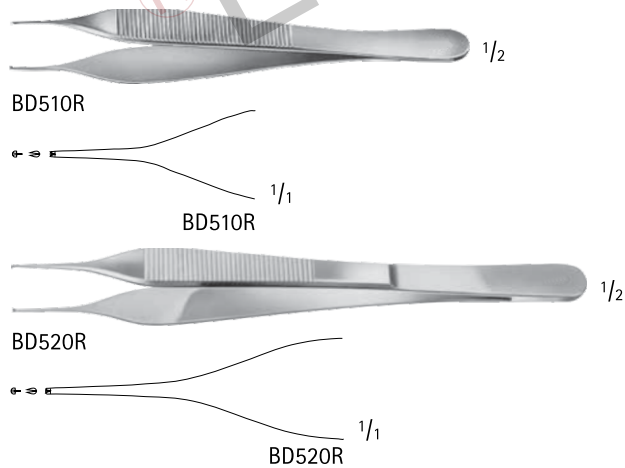

MICRO ADSON Tissue Forceps, Delicate

Catalog Number	Teeth	Length (in.)
BD510R	1 x 2	4 3/4
BD520R	1 x 2	6



BD662R-BD664R

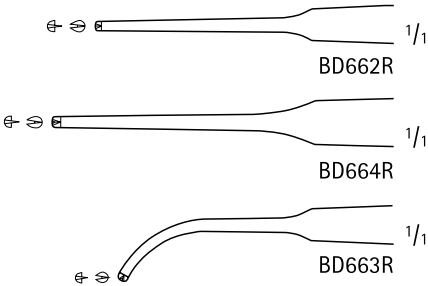

GERALD Tissue Forceps, Delicate

Catalog Number	Tip	Teeth	Length (in.)
BD662R	STR	1 x 2	6 7/8
BD664R	STR	1 x 2	9
BD663R	CVD	1 x 2	6 7/8



MG422R

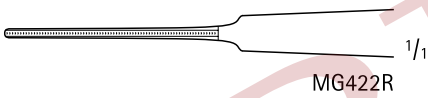

GERALD-DEBAKEY Forceps, Narrow

Catalog Number	Tip	Length (in.)
MG422R	SERR	9

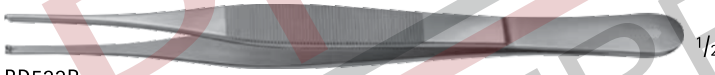

BD522R



ADSON Tissue Forceps, Delicate

Catalog Number	Teeth	Length (in.)
BD522R	1 x 2	7



BD523R

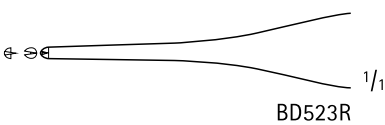

JEFFERSON Tissue Forceps, Delicate

Catalog Number	Teeth	Length (in.)
BD523R	1 x 2	7



BD238R-BD243R

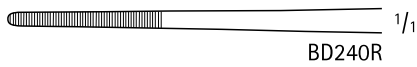

CUSHING Forceps, Delicate

Catalog Number	Tip	Length (in.)
BD238R	STR, SERR	7
BD239R	STR, SERR	7 7/8
BD240R	STR, SERR	9 3/4
BD243R	CVD, SERR	7 7/8

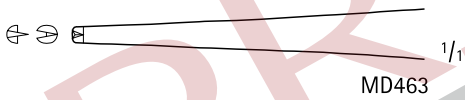

CUSHING Tissue Forceps

Catalog Number	Teeth	Length (in.)
MD463	1 x 2	7

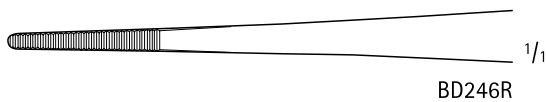

BROPHY Forceps, Delicate

Catalog Number	Tip	Length (in.)
BD246R	SERR	7 7/8



BD231R-BD232R



BD231R

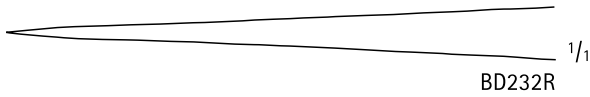

BD232R

Forceps, Delicate

Catalog Number	Tip	Length (in.)
BD231R	SMOOTH	7
BD232R	SMOOTH	7 7/8



BD301R-BD305R



BD301R



BD302R



BD303R



BD304R



BD305R

Micro Dressing Forceps

Catalog Number	Tip	Length (in.)
BD301R	STR, SERR	3 1/2
BD302R	STR, SERR	4 1/8
BD303R	STR, SERR	4 1/2
BD304R	STR, SERR	5 1/8
BD305R	STR, SERR	5 3/4
BD311R	CVD, SERR	3 1/2
BD312R	CVD, SERR	4 1/8
BD313R	CVD, SERR	4 1/2
BD314R	CVD, SERR	5 1/8
BD315R	CVD, SERR	5 3/4



BD311R-BD315R



BD311R

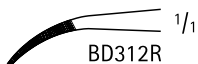

BD312R



BD313R



BD314R



BD315R



BD660R



BD660R

GILLIES Tissue Forceps, Delicate

Catalog Number	Tip	Teeth	Length (in.)
BD660R	X-SERR	1 x 2	6 1/8



BD669R



BD669R

SEMKEN Tissue Forceps, Delicate

Catalog Number	Teeth	Length (in.)
BD669R	1 x 2	5 3/4



BD670R-BD679R



BD670R



BD671R



BD672R

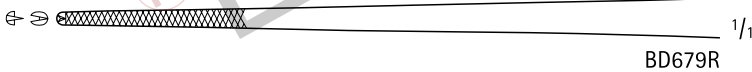

BD679R

WAUGH Tissue Forceps, Delicate

Catalog Number	Tip	Teeth	Length (in.)
BD670R	X-SERR	1 x 2	7
BD671R	X-SERR	1 x 2	7 7/8
BD672R	X-SERR	1 x 2	9 3/4
BD679R	X-SERR	1 x 2	12



MB211R



MB211R

DOCKTOR Forceps

Catalog Number	Tip	Teeth	Length (in.)
MB211R	X-SERR	1 x 2	4 3/4



FB394R-FB396R



FB394R-FB396R

DEBAKEY Atraumatic Vascular Tissue Forceps

Catalog Number	Tip Size (mm)	Length (in.)
FB394R	1	6
FB395R	1	7 3/4
FB396R	1	9 1/2



FB411R-FB419R

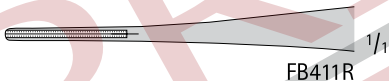

FB411R



FB412R



FB418R



FB419R

DEBAKEY Atraumatic Forceps

Catalog Number	Tip Size (mm)	Length (in.)
FB411R	1.5	6
FB412R	1.5	7 7/8
FB418R	1.5	9 1/2
FB419R	1.5	11 3/4



FB400R-FB409R



FB400R



FB402R



FB404R



FB405R



FB414R



FB415R



FB416R



FB417R



FB406R



FB407R



FB408R



FB409R

DEBAKEY Atraumatic Forceps

Catalog Number	Tip Size (mm)	Length (in.)
FB400R	2	6
FB402R	2	7 7/8
FB404R	2	9 1/2
FB405R	2	11 3/4
FB414R	2.8	6
FB415R	2.8	7 7/8
FB416R	2.8	9 1/2
FB417R	2.8	11 3/4
FB406R	3.5	7 7/8
FB407R	3.5	9 1/2
FB408R	3.5	11 3/4
FB409R	3.5	13 3/4



FB401R-FB410R

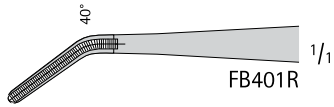

FB401R

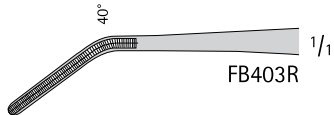

FB403R

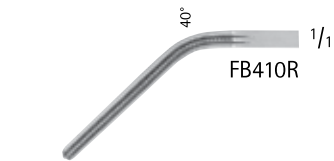

FB410R

DEBAKEY Atraumatic Forceps, Angled

Catalog Number	Tip Size (mm)	Length (in.)
FB401R	2	6
FB403R	2	7 7/8
FB410R	2	9 1/2

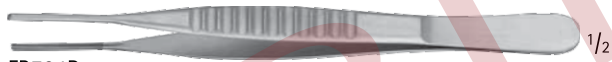

FB784R

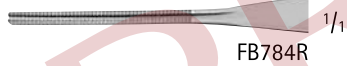

FB784R



FB785R

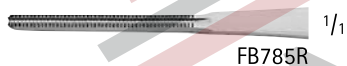

FB785R



FB786R



FB786R

COOLEY Atraumatic Vascular Tissue Forceps

Catalog Number	Tip Size (mm)	Length (in.)
FB784R	1.5	6
FB785R	2.0	7 3/4
FB786R	2.3	9 1/2



BD250R



BD250R

COOLEY Vascular Tissue Forceps

Catalog Number	Length (in.)
BD250R	7 7/8