

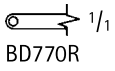

BD770R



BD770R

MILLS Mammary/Coronary Tissue Forceps

Catalog Number	Length (in.)
BD770R	7



FB130R



FB130R

Dilator Forceps

Catalog Number	Tip Size (mm)	Length (in.)
FB130R	0.2	4 1/2



BD980R



BD980R

HUNTER Splinter Forceps

Catalog Number	Length (in.)
BD980R	4 1/8

DUROGRIP Tungsten Carbide Tissue Forceps

- Cross-Serrated Platform tips for firm and non-traumatic grip
- Long working life
- Gold-plated end

DUROGRIP TC ADSON Forceps

Catalog Number	Tip	Teeth	Length (in.)
BD151R	X-SERR	-	4 3/4
US109	X-SERR	1 x 2	4 3/4
US110	DEL, X-SERR	1 x 2	4 3/4
MB484R	X-SERR	1 x 2	6
MB485R	DEL, X-SERR	1 x 2	6



BD151R

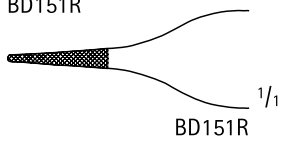

BD151R



US109-US110

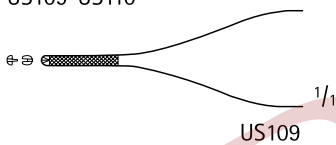

US109

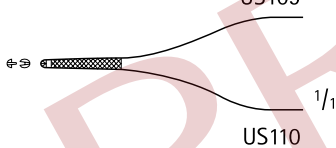

US110



MB484R-MB485R



MB484R

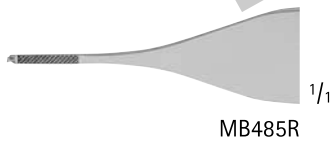

MB485R



US112

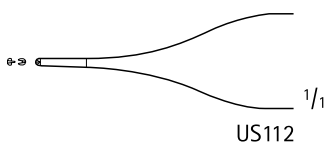

US112

DUROGRIP TC GORNEY-ADSON Forceps

Catalog Number	Tip	Teeth	Length (in.)
US112	DEL, SMOOTH	1 x 2	4 3/4

GENERAL SURGERY DUROGRIP TC TISSUE FORCEPS



MB779R-MB781R, US117-US120

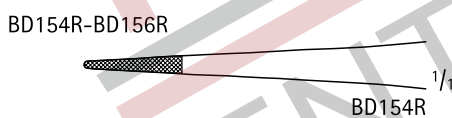
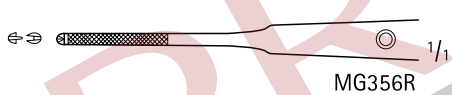
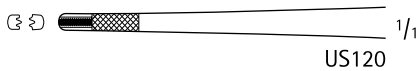

BD157R-BD159R

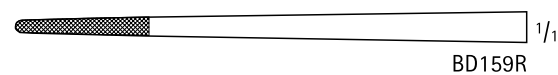
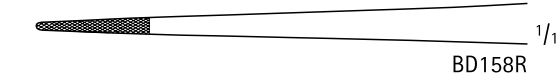

DUROGRIP TC DEBAKEY Needle Forceps

Catalog Number	Tip	Tip Size (mm)	Length (in.)
MB782R	-	1.5	6
MB783R	-	1.5	7 3/4
US119	NARROW	1.5	7 3/4
MB779R	-	2	6
MB780R	-	2	8
MB781R	-	2	10 1/2
US117	-	2	6
US118	-	2	8
US120	NARROW	2	9

GERALD Needle Forceps

Catalog Number	Tip	Teeth	Length (in.)
MG356R	X-SERR	1 x 2	6 7/8

DUROGRIP TC (POTTS-SMITH) Thumb Forceps

Catalog Number	Tip	Length (in.)
BD154R	X-SERR	5 3/4
BD156R	X-SERR	7
BD157R	X-SERR	7 7/8
BD158R	X-SERR	9
BD159R	X-SERR	9 3/4



BD160R-BD198R

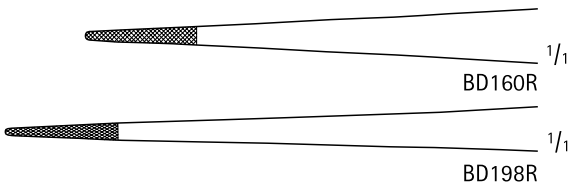

**DUROGRIP TC CUSHING Forceps,
W/ Scraper End**

Catalog Number	Tip	Length (in.)
BD160R	X-SERR	7
BD198R	X-SERR	9 3/4



MB308R

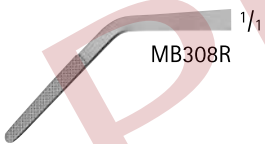

DUROGRIP TC CUSHING Forceps

Catalog Number	Tip	Length (in.)
MB308R	ANG, X-SERR	6 1/4



US111



DUROGRIP TC SEMKEN Forceps

Catalog Number	Tip	Tip Size (mm)	Teeth	Length (in.)
US111	X-SERR	1	1 x 2	6 1/4



BD164R-BD166R

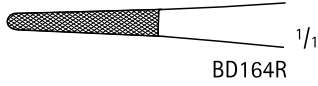

BD164R



BD165R



BD166R

DUROGRIP TC STANDARD Forceps

Catalog Number	Tip	Length (in.)
BD164R	X-SERR	5 3/4
BD165R	X-SERR	7 7/8
BD166R	X-SERR	9 3/4



BD168R



BD168R

DUROGRIP TC GRUENWALD Forceps

Catalog Number	Tip	Length (in.)
BD168R	X-SERR	7 1/4



BD171R-BD173R

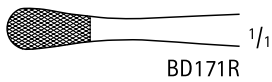

BD171R



BD173R

DUROGRIP TC WANGENSTEEN Forceps

Catalog Number	Tip	Length (in.)
BD171R	X-SERR	6
BD173R	X-SERR	9

LAHEY Forceps

Catalog Number	Teeth	Length (in.)
BF309R	2 x 2	6 1/8
BF310R	3 x 3	6 1/8
MG360R	3 x 3	8
BF311R	4 x 4	6 1/8



BF309R

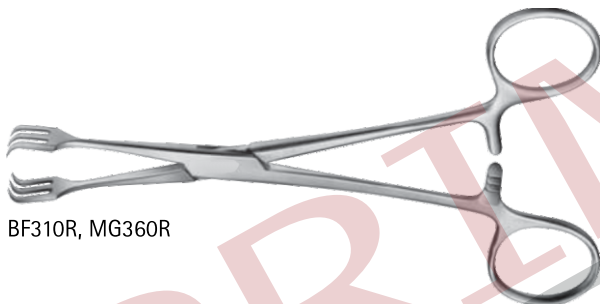
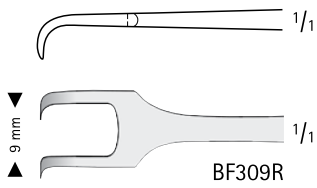

BF310R, MG360R

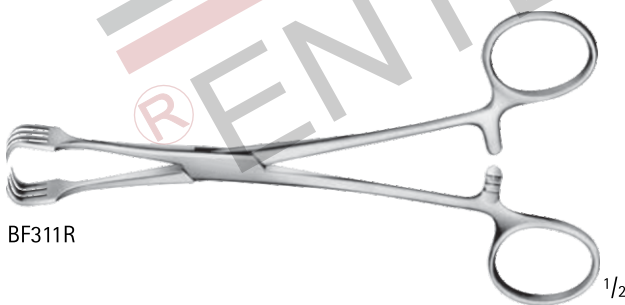
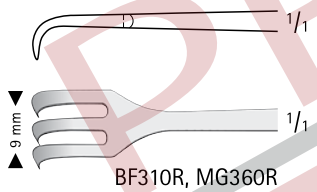

BF311R

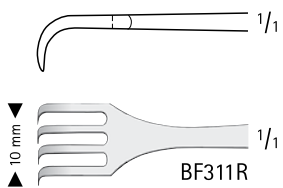

BOYS-ALLIS Forceps

Catalog Number	Teeth	Length (in.)
EA010R	5 x 6	6 1/8



EA010R



EA010R

Baby ALLIS Forceps

Catalog Number	Teeth	Length (in.)
EA012R	4 x 5	5 1/8



EA012R



EA012R

ALLIS Forceps

Catalog Number	Teeth	Length (in.)
EA015R	4 x 5	6 1/8
EA016R	5 x 6	6 1/8
EA017R	5 x 6	7 1/2
FB938R	5 x 6	8 3/4
EA018R	5 x 6	10
MB910R	5 x 6	16

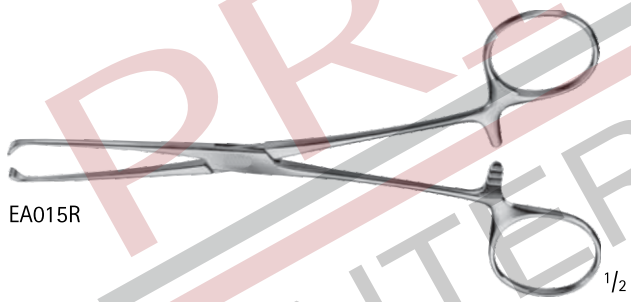

EA015R



EA015R

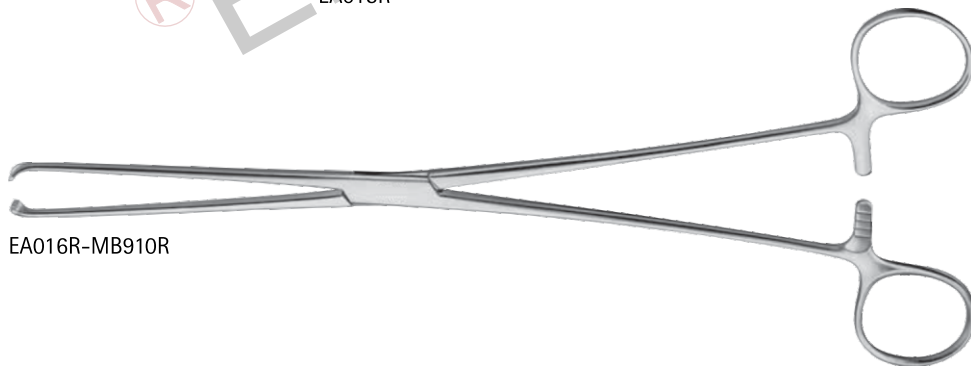

EA016R-MB910R



EA016R-MB910R

ALLIS Forceps, Heavy Version

Catalog Number	Teeth	Length (in.)
MG235R	4 x 5	6 1/8
MG236R	5 x 6	6 1/8
MG237R	5 x 6	7 7/8

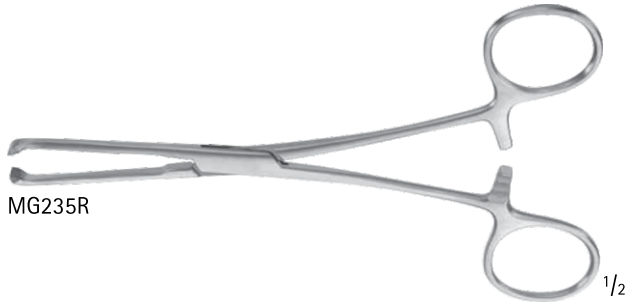

MG235R



MG235R

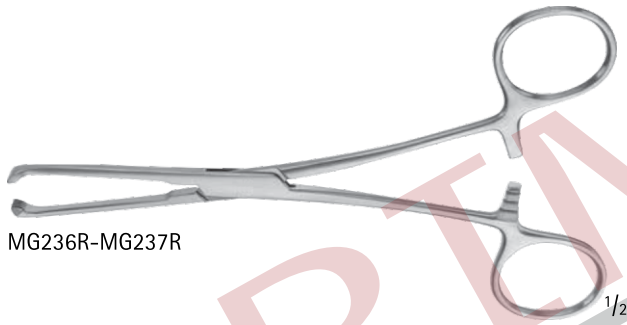

MG236R-MG237R

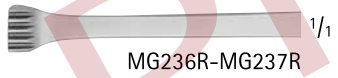

MG236R-MG237R

ALLIS-THOMS Forceps

Catalog Number	Teeth	Length (in.)
EA020R	6 x 7	7 7/8



EA020R



EA020R

JUDD-ALLIS Forceps

Catalog Number	Teeth	Length (in.)
EA025R	3 x 4	6 1/8
EA026R	3 x 4	7 7/8

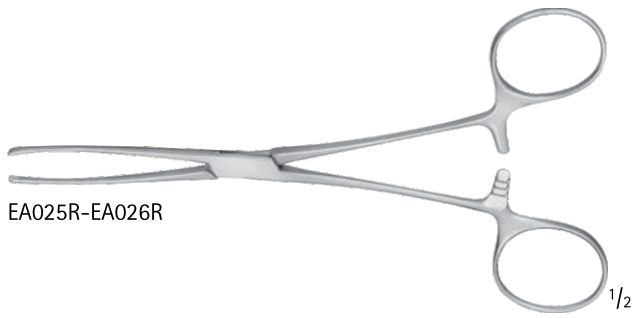

ALLIS-ADAIR Clamp

Catalog Number	Teeth	Length (in.)
MD568	9 x 10	6 1/4

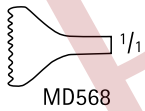
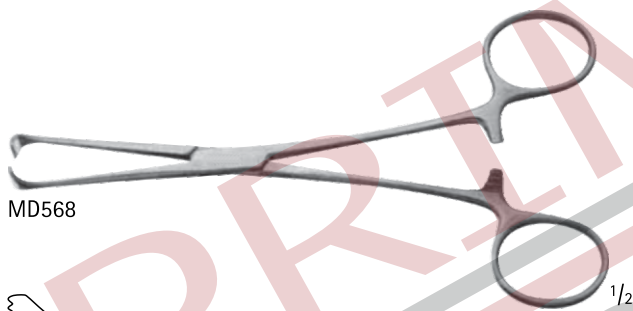

LOCKWOOD-ALLIS Intestinal Clamp

Catalog Number	Teeth	Length (in.)
MG455R	4 x 5	6 1/2

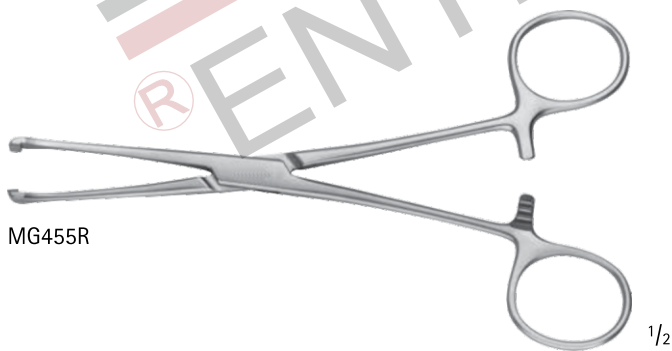

ALLIS Atraumatic Forceps

Catalog Number	Length (in.)
EA092R	6 1/4
EA095R	7 7/8
EA096R	8 3/4
EA097R	10
EA100R	11 5/8
EA099R	11 3/4
EA101R	14



EA092R-EA099R

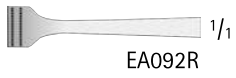

EA092R

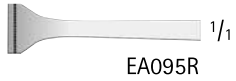

EA095R



EA096R

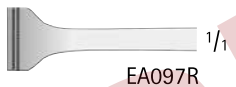

EA097R



EA099R



EA100R-EA101R

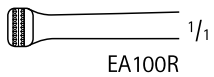

EA100R

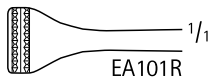

EA101R

**GLASSMAN-ALLIS Common Duct
 Forceps Non-Crushing**

Catalog Number	Length (in.)
MG435R	8 1/2



MG435R



MG435R

BABCOCK Tissue Holding Forceps

Catalog Number	Length (in.)
MB136R	12
MB137R	14



MB136R-MB137R



MB136R

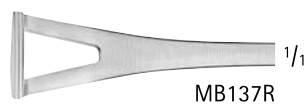

MB137R



EA030R-MG359R

BABCOCK Forceps

Catalog Number	Tip	Length (in.)
MG359R	-	5 1/2
EA030R	-	6 1/8
EA031R	-	6 7/8
EA032R	-	8 1/2
FB934R	-	8 3/4
MB300R	-	14
MB911R	DEL, PETITE	16



MG359R



EA030R



EA031R



EA032R

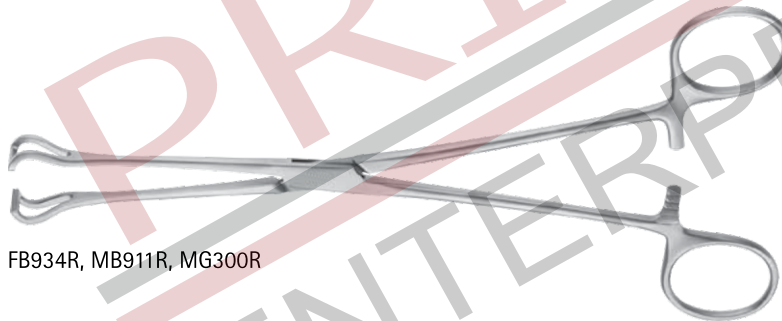

FB934R, MB911R, MG300R

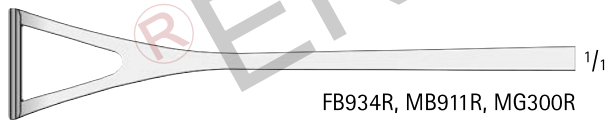

FB934R, MB911R, MG300R

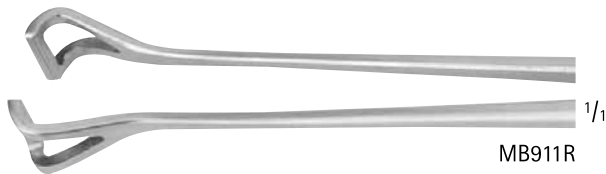

MB911R

BABCOCK Atraumatic Forceps

Catalog Number	Length (in.)
EA050R	6 1/4
EA052R	8 1/2
FB936R	8 3/4
MD470	9 1/2

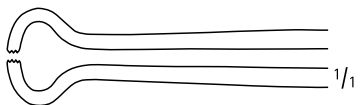
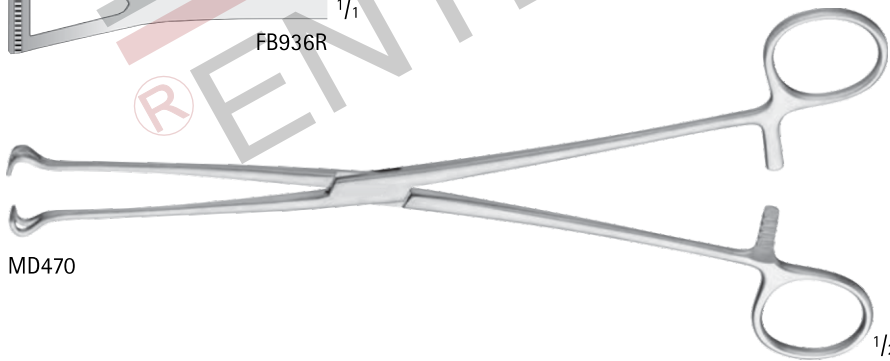
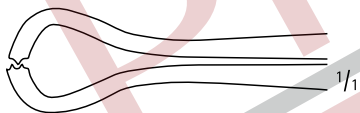
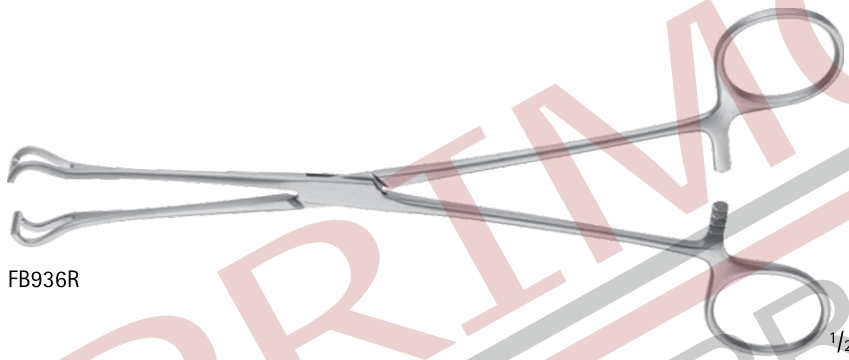
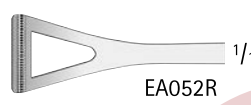
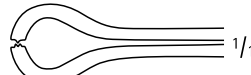
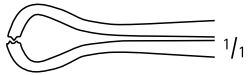
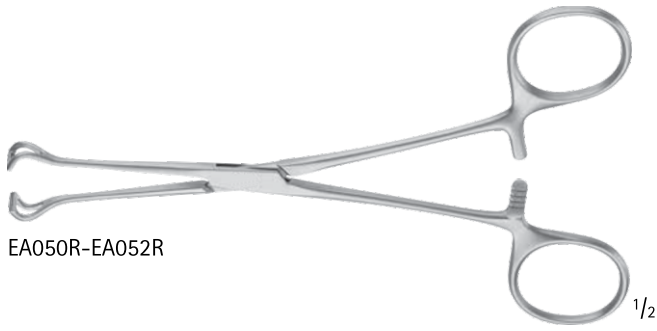

DUROGRIP™ TC BABCOCK Forceps

Catalog Number	Length (in.)
MG364R	6 1/4
MB338R	8 1/4

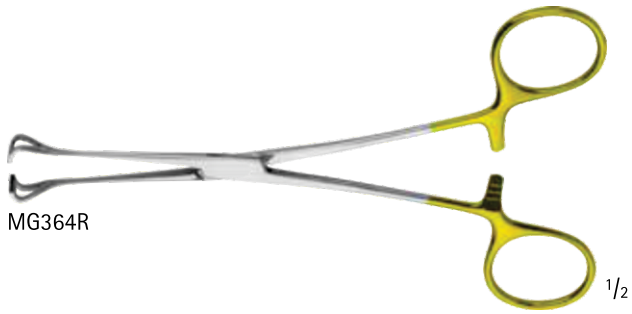

MG364R

1/2



MG364R

1/1

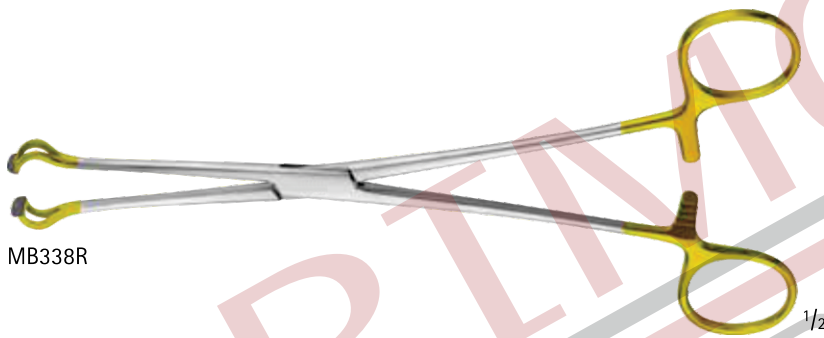

MB338R

1/2



MB338R

1/1

ALLIS Intestinal Grasping Forceps

Catalog Number	Length (in.)
EA022R	7 1/2
EA023R	11 1/2



EA022R-EA023R

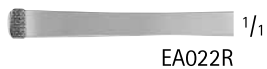

EA022R

1/1



EA023R

1/1

COLLIN Intestinal Forceps

Catalog Number	Length (in.)
EA039R	5 1/2
EA040R	7



EA039R

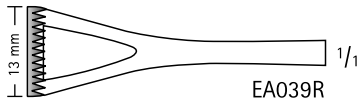

EA039R

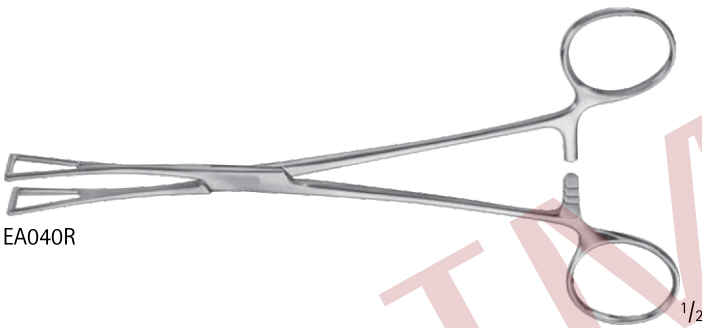

EA040R

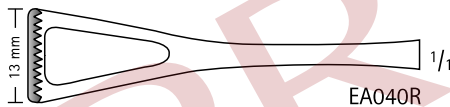

EA040R

COLLIN Atraumatic Forceps

Catalog Number	Length (in.)
EA061R	7 3/4
EA062R	9

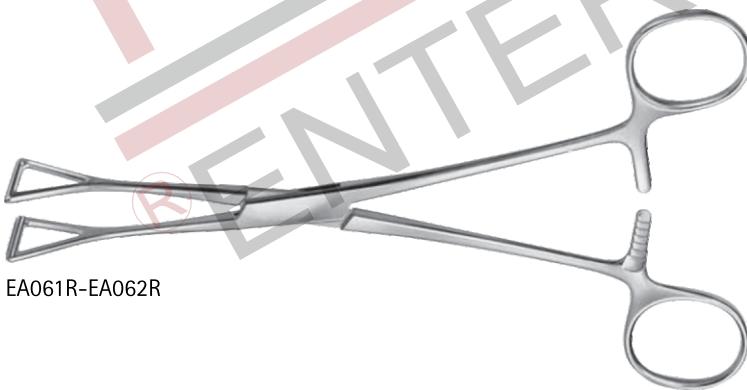

EA061R-EA062R

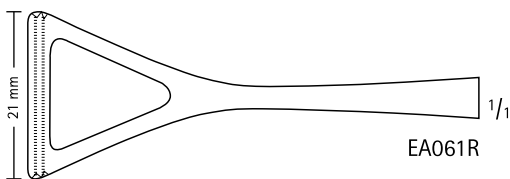

EA061R

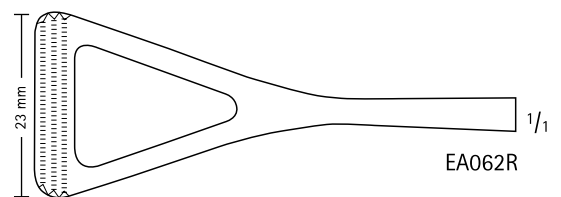

EA062R

DUVAL-COLLIN Intestinal Forceps

Catalog Number	Length (in.)
EA041R	7 3/4
EA042R	7 7/8

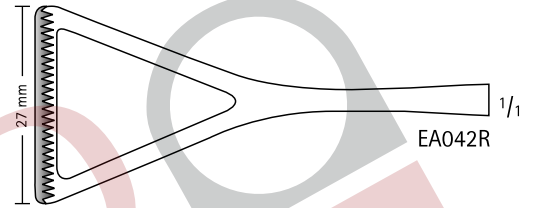
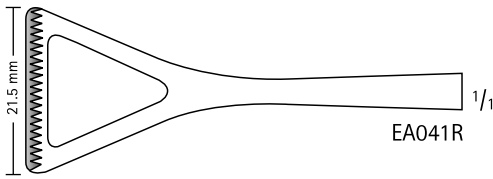
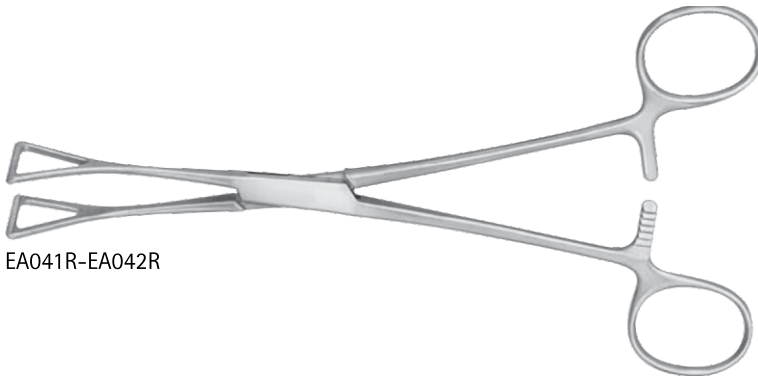

PENNINGTON Forceps

Catalog Number	Length (in.)
BH902R	6 1/8
EA037R	7 7/8

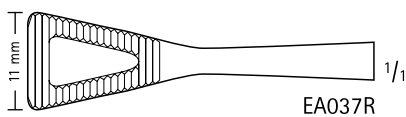
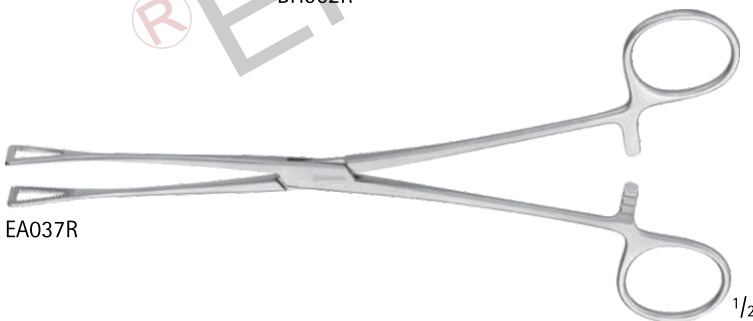
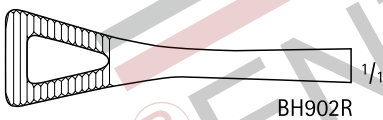
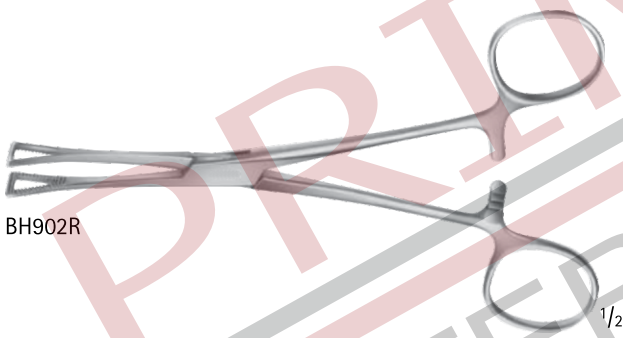

**BAINBRIDGE Intestinal Forceps,
 Longitudinal Serrations**

Catalog Number	Jaw	Length (in.)
EA106R	STR	6 1/8
US114	STR	7 1/4
EA107R	CVD	6 1/8
US115	CVD	7 1/4

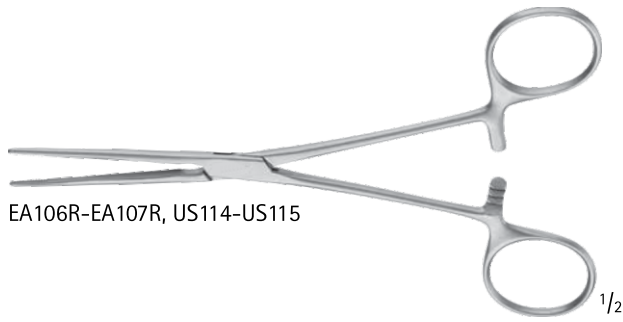

EA106R-EA107R, US114-US115



EA106R



US114

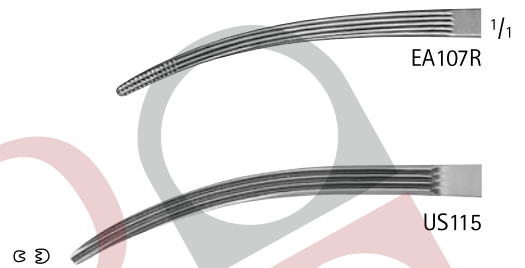

EA107R



US115

**ALLEN Intestinal Forceps, Longitudinal
 Serrated**

Catalog Number	Teeth	Length (in.)
EA114R	1 x 2	6 1/8
MB609R	1 x 2	7 7/8

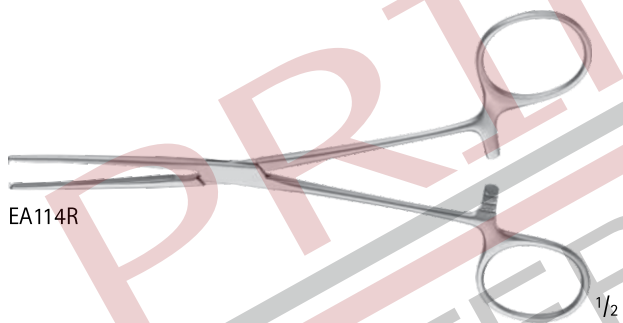

EA114R



EA114R



MB609R



MB609R

DOYEN Intestinal Forceps, Elastic Blades

Catalog Number	Jaw	Length (in.)
EA120R	STR	6 1/2
EA126R	STR	9 1/4
EA121R	CVD	6 1/2
EA127R	CVD	9 1/4

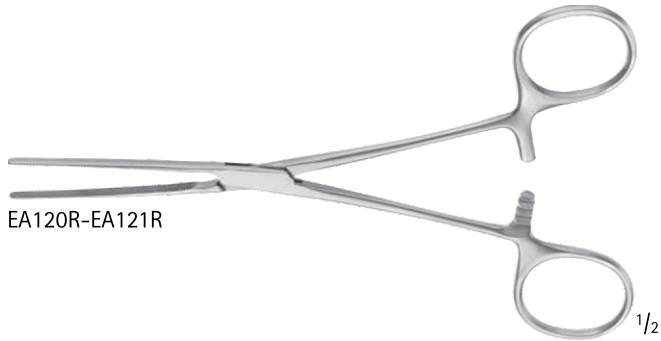

EA120R-EA121R



EA120R



EA121R

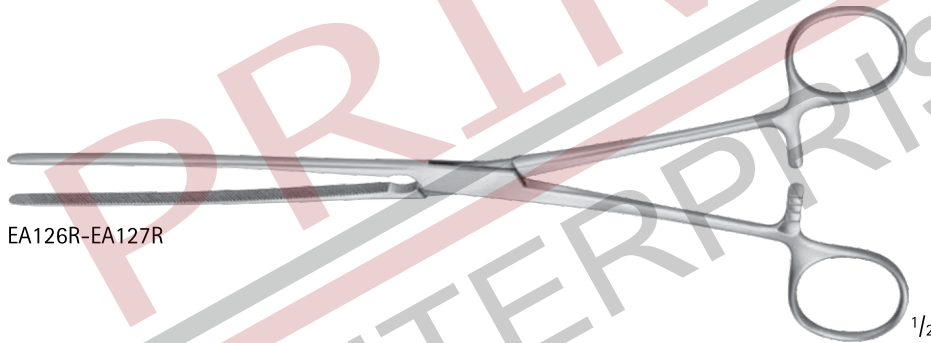

EA126R-EA127R

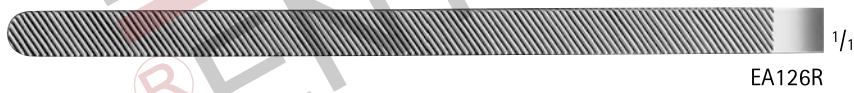

EA126R

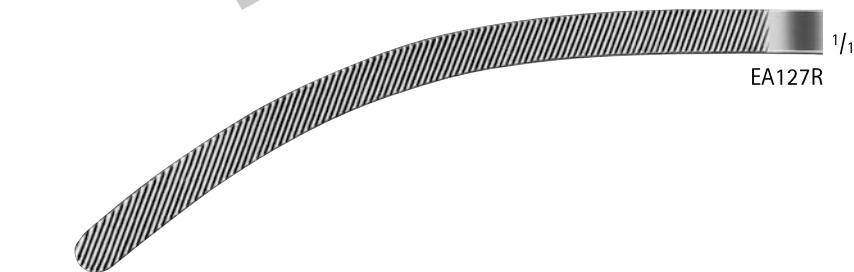

EA127R

**DOYEN Intestinal Forceps, Elastic
 Blades, Longitudinal Serations**

Catalog Number	Jaw	Length (in.)
EA130R	STR	9 1/2
EA131R	CVD	9 1/2



EA130R-EA131R

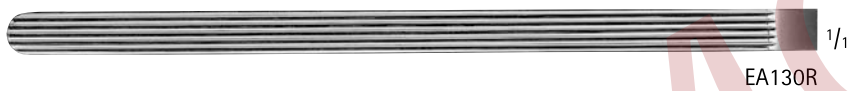

EA130R

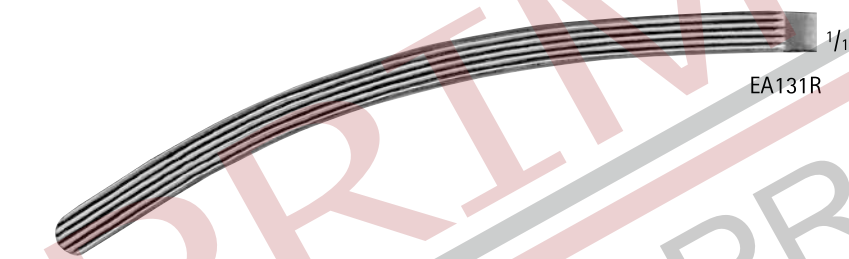

EA131R

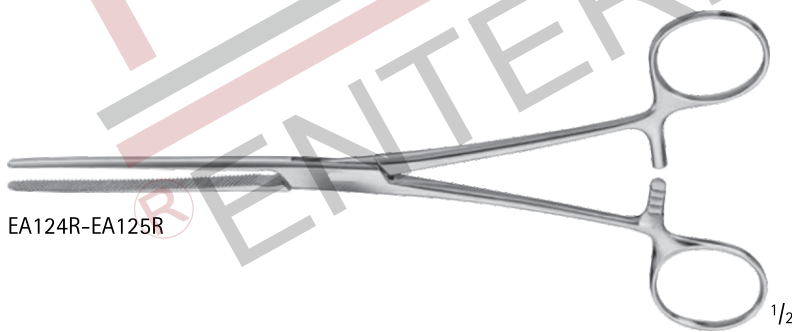

EA124R-EA125R

**HARTMANN Intestinal Clamp, Elastic
 Blades**

Catalog Number	Jaw	Length (in.)
EA124R	STR	7 7/8
EA125R	CVD	7 7/8



EA124R



EA125R



EA150R-EA156R

KOCHER Intestinal Forceps, Elastic Blades

Catalog Number	Jaw	Length (in.)
EA150R	STR	8 3/4
EA151R	STR	9 3/4
EA152R	STR	11
EA155R	CVD	8 3/4
EA156R	CVD	9 3/4



EA150R



EA151R



EA152R



EA155R



EA156R

**MAYO-ROBSON Intestinal Forceps,
 Hard Elastic Blades**

Catalog Number	Jaw	Length (in.)
EA170R	STR	9 3/4
EA171R	CVD	9 3/4

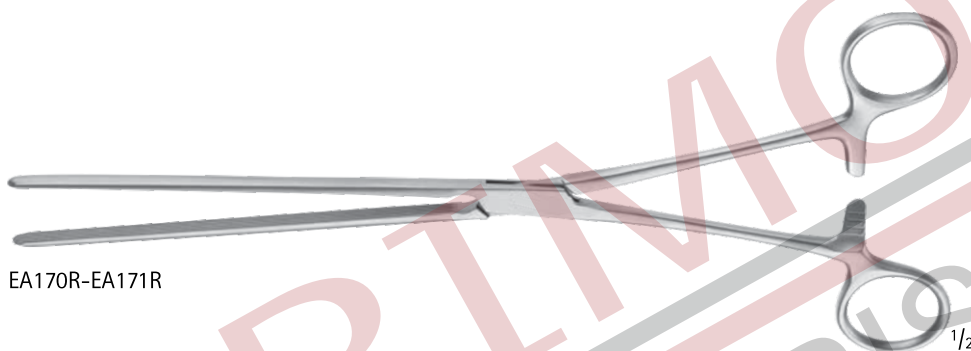

EA170R-EA171R



EA170R

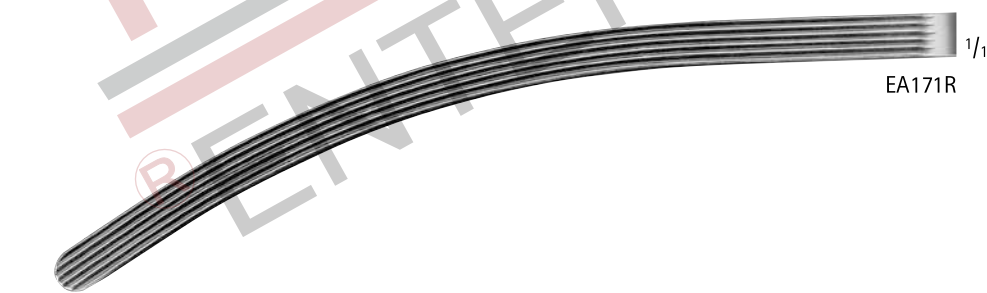

EA171R

GENERAL SURGERY
ABDOMINAL & INTESTINAL
GRASPING FORCEPS



PAYR Intestinal Clamp

Catalog Number	Length (in.)
EA305R	7
EA306R	7 7/8
EA309R	10 3/4
EA450R	12 1/2

EA305R-EA450R

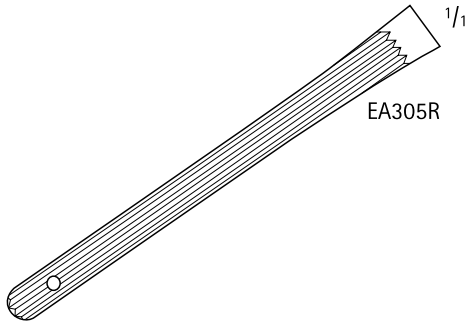

EA305R

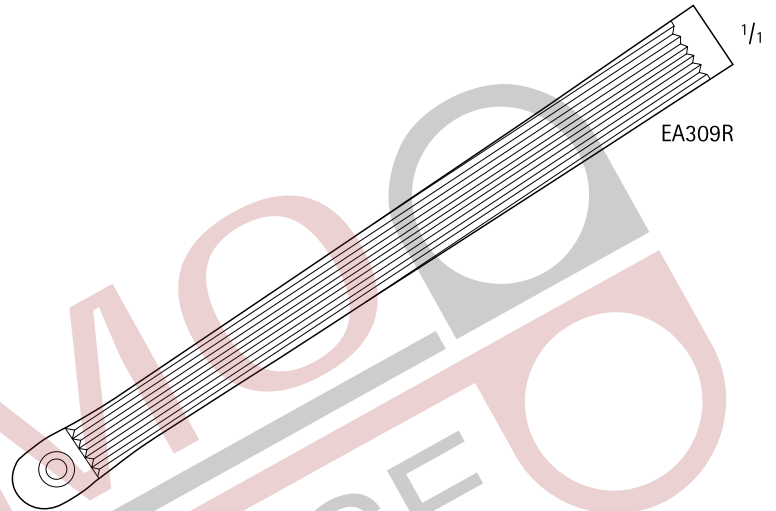

EA309R

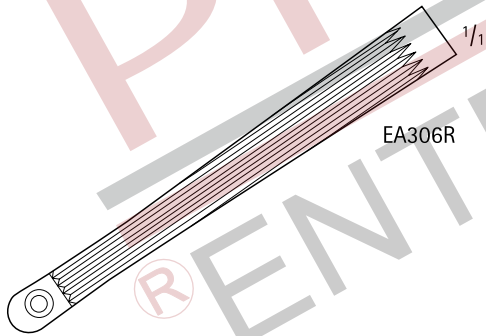

EA306R

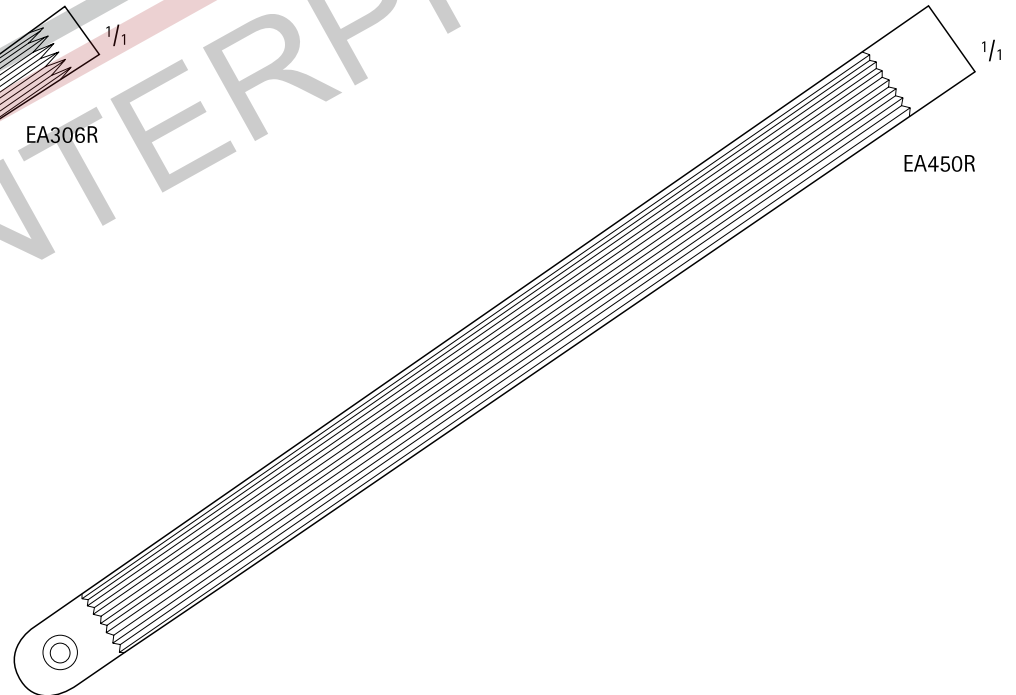

EA450R

MIXTER Gall Duct Forceps

Catalog Number	Jaw	Length (in.)
MB120R	HEAVY-CVD	6 1/4



MB120R

1/2

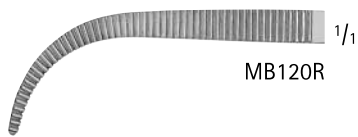

MB120R

1/1

SHALLCROSS Cystic Duct Forceps

Catalog Number	Jaw	Length (in.)
MB126R	CVD	6 7/8
US152	FULL-CVD	8



MB126R, US152

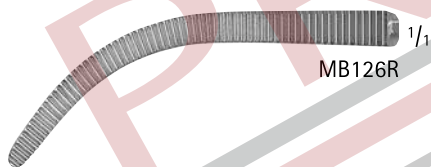

MB126R

1/1

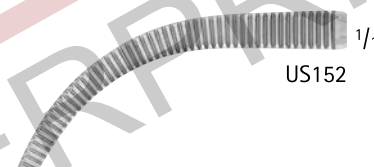

US152

1/1



EB220R-EB221R

1/2



EB220R

1/1

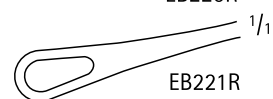

EB221R

1/1

BLAKE Gall Stone Forceps

Catalog Number	Jaw	Length (in.)
EB220R	STR	8
EB221R	CVD	8

DESJARDINS Gall Stone Forceps

Catalog Number	Tip	Length (in.)
EB231R	OVAL	8 7/8
EB232R	OVAL	8 7/8
EB233R	TAPERED	8 7/8
EB234R	TAPERED	8 7/8



EB231R-EB234R

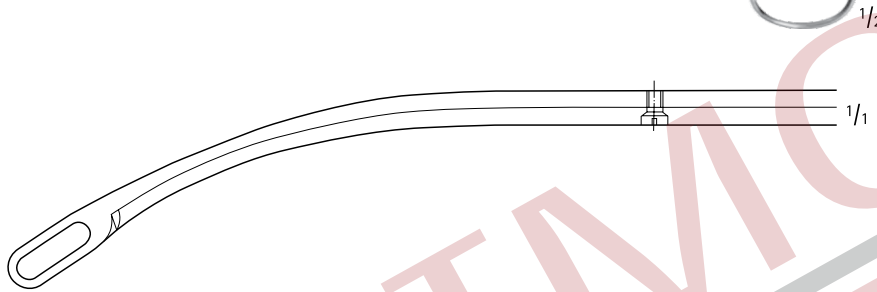

EB231R

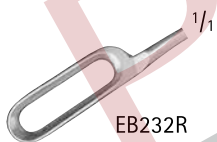

EB232R



EB233R



EB234R

PARKER-KERR Forceps

Catalog Number	Jaw	Length (in.)
EA365R	SLIGHT-CVD	9 3/4



HEIMING Kidney Stone Forceps

Catalog Number	Jaw	Length (in.)
EF047R	SLIGHT-CVD	6 3/4
EF048R	HEAVY-CVD	6 1/4

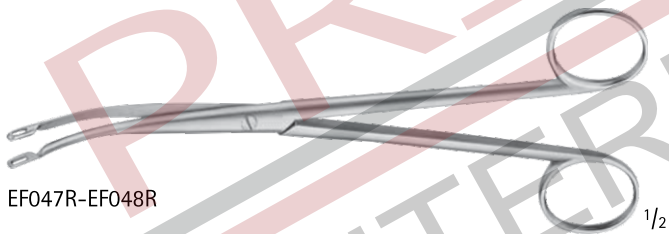

RANDALL Kidney Stone Forceps

Catalog Number	Jaw	Length (in.)
EF051R	SLIGHT-CVD	8 7/8
EF052R	CVD	8 7/8
EF053R	HEAVY-CVD	8 7/8
EF054R	U-CVD	8 7/8



EF051R-EF054R

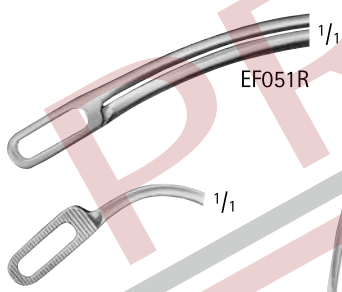

EF051R

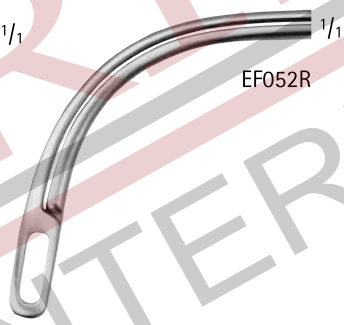

EF052R

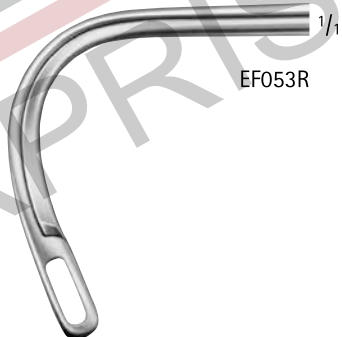

EF053R

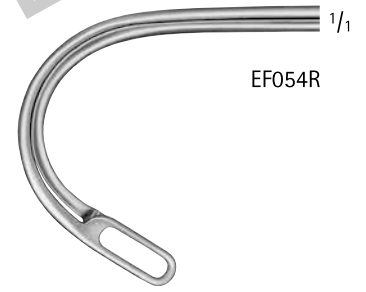

EF054R

RANDALL Kidney Stone Forceps
(continued)

Catalog Number	Jaw	Length (in.)
EF055R	CVD	7 1/2
EF056R	HEAVY-CVD	7 1/2
EB244R	90° ANG	9 5/8
EB246R	HEAVY-CVD, DEL	9



EF055R-EF056R

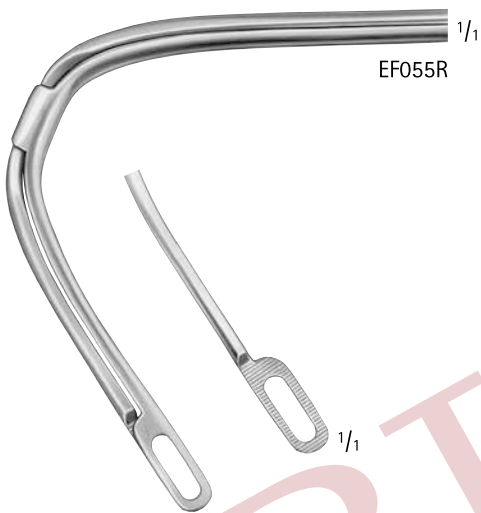

EF055R ^{1/1}

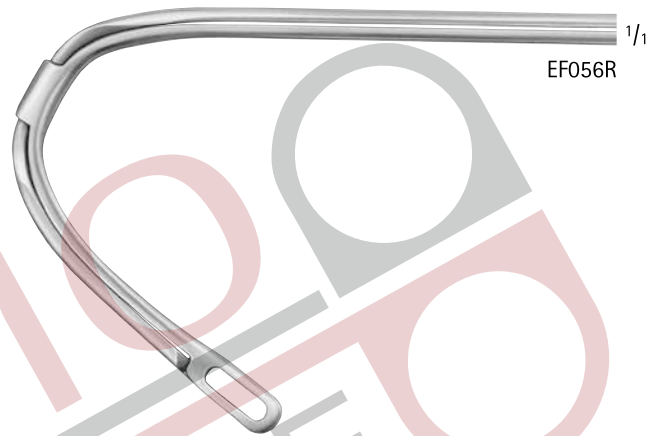

EF056R ^{1/1}

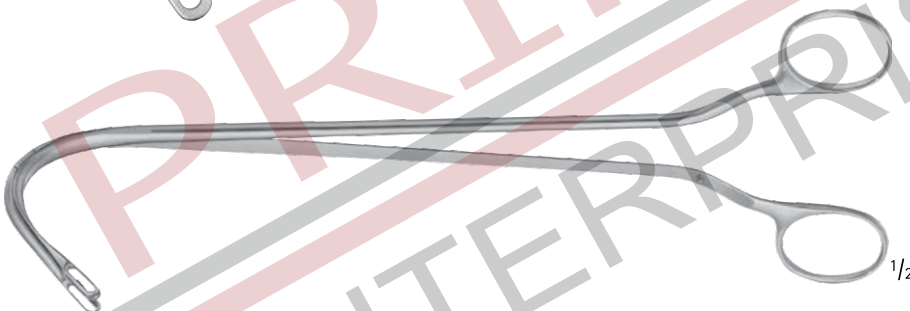

EB244R ^{1/2}



EB244R ^{1/1}

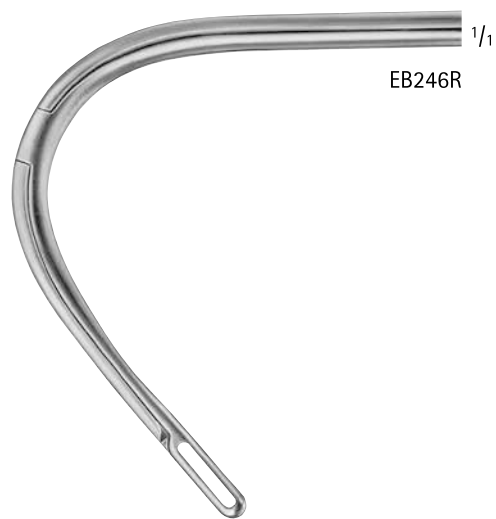

EB246R ^{1/1}

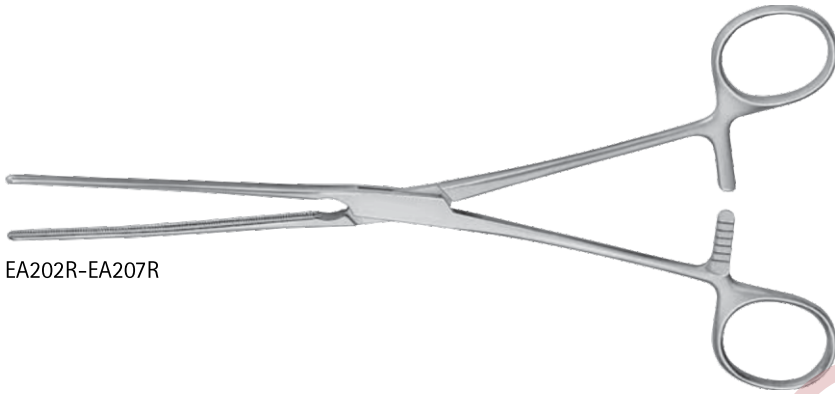

EA202R-EA207R

**KOCHER Atraumatic Forceps,
 Elastic Blades**

Catalog Number	Jaw	Length (in.)
EA202R	STR	8 3/4
EA204R	STR	9 3/4
EA206R	STR	11
EA203R	CVD	8 3/4
EA205R	CVD	9 3/4
EA207R	CVD	11

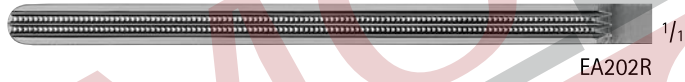

EA202R

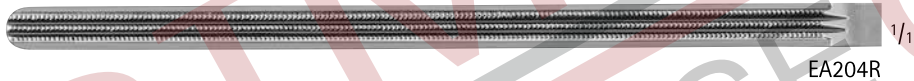

EA204R

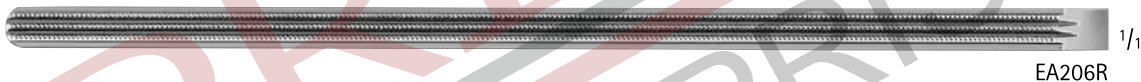

EA206R



EA203R



EA205R



EA207R

**HARTMANN Atraumatic Forceps,
 Elastic Blades**

Catalog Number	Jaw	Length (in.)
EA210R	STR	7 7/8
EA211R	CVD	7 7/8

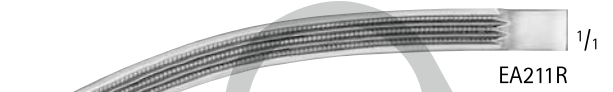
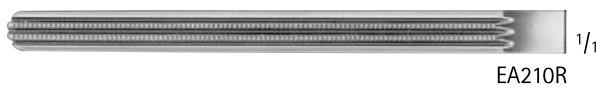

MAYO-ROBSON Atraumatic Forceps

Catalog Number	Jaw	Length (in.)
EA216R	STR	9 3/4
EA217R	CVD	9 3/4

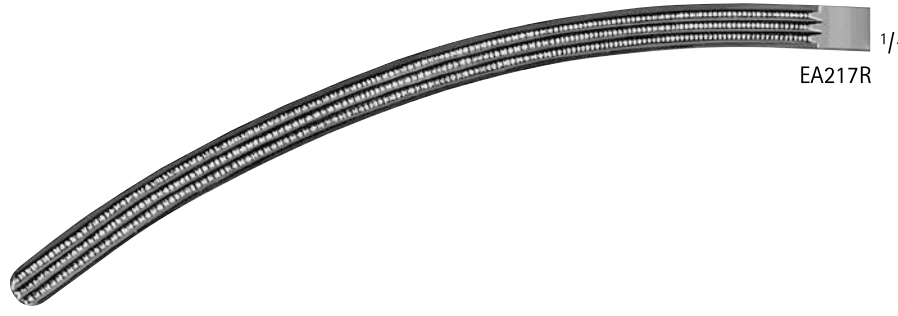
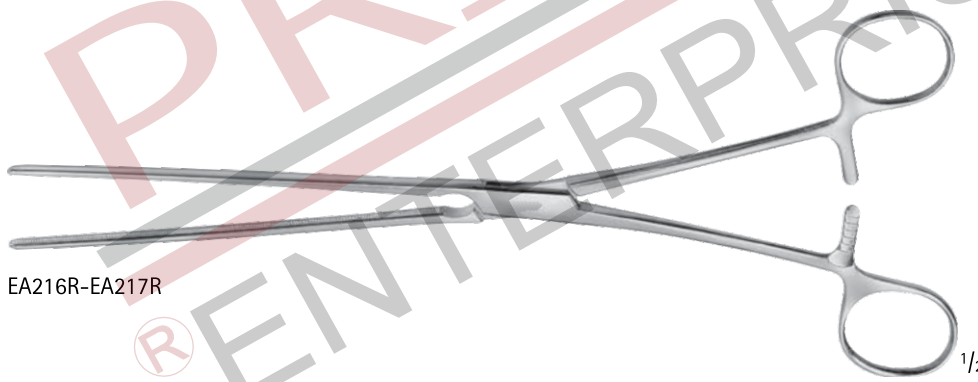

**DOYEN Atraumatic Forceps,
 Elastic Blades**

Catalog Number	Jaw	Length (in.)
EA222R	STR	6 3/4
EA212R	STR	9
EA223R	CVD	6 3/4
EA213R	CVD	9

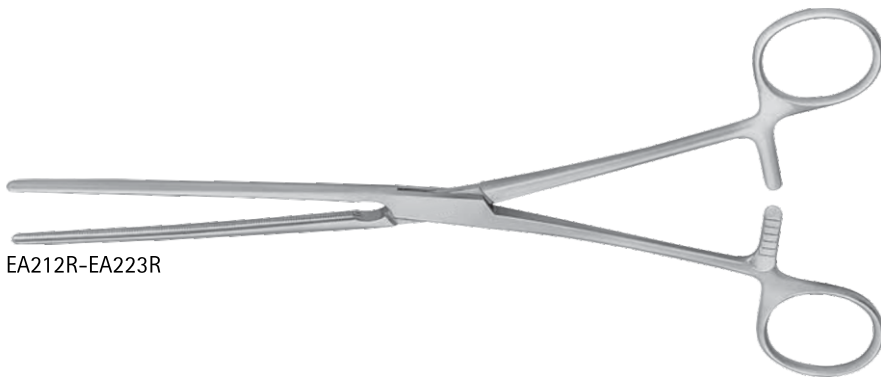

EA212R-EA223R



EA222R



EA212R



EA223R

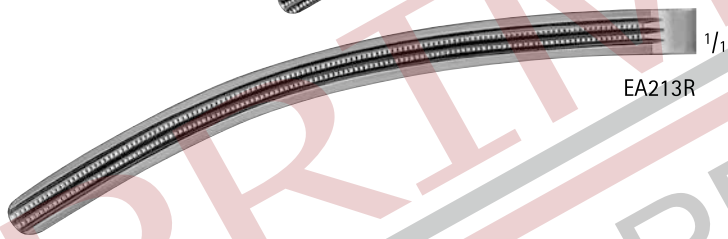

EA213R

SCUDDER Atraumatic Forceps

Catalog Number	Jaw	Length (in.)
EA240R	STR	13



EA240R



EA240R

CARTER-GLASSMAN Resection Clamp

Catalog Number	Jaw	Jaw Length (mm)	Length (in.)
MG460R	STR	110	11
MG439R	45° ANG	103	10 1/4



MG460R

1/2



MG460R

1/1

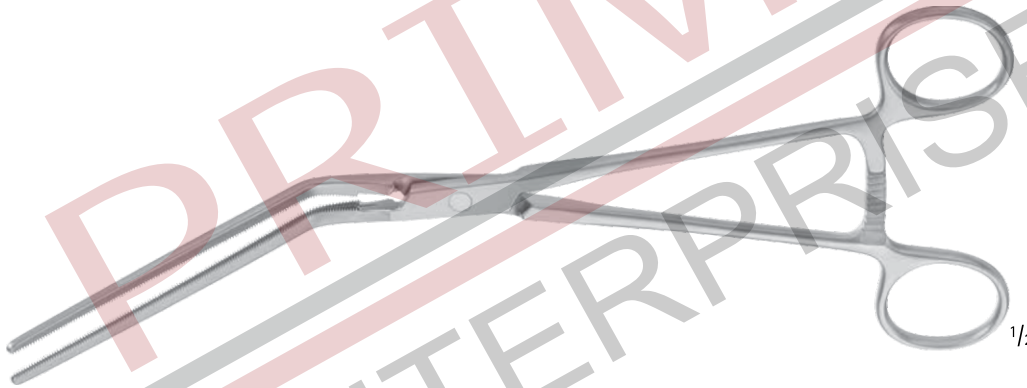

MG439R

1/2

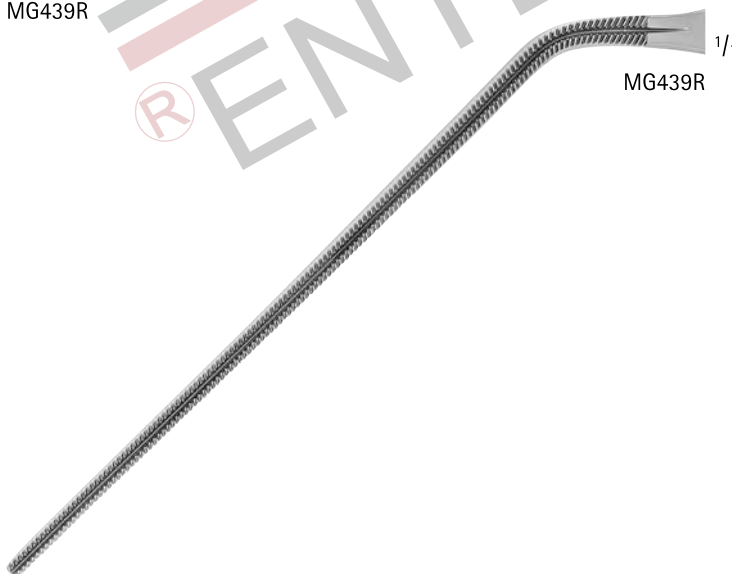

MG439R

1/1

**GLASSMAN Intestinal and Liver
Holding Clamp, Non-Crushing**

Catalog Number	Jaw	Length (in.)
MG436R	STR	9 3/4
MG437R	CVD	9 5/8
MG438R	FULL CVD	9

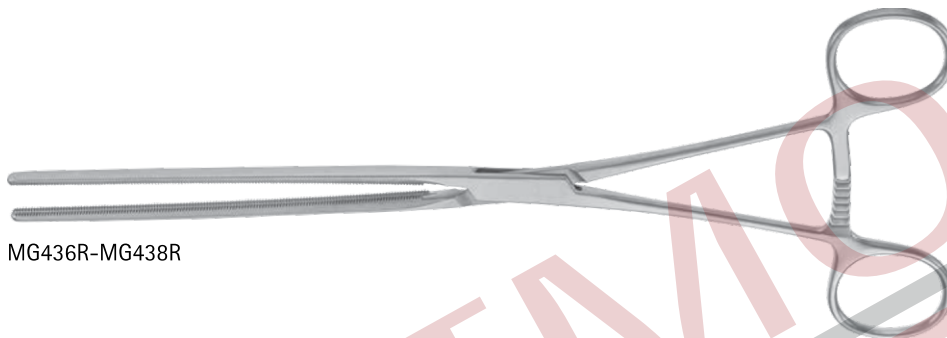

MG436R-MG438R

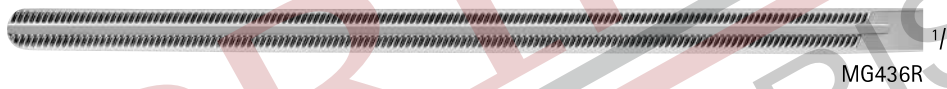

MG436R

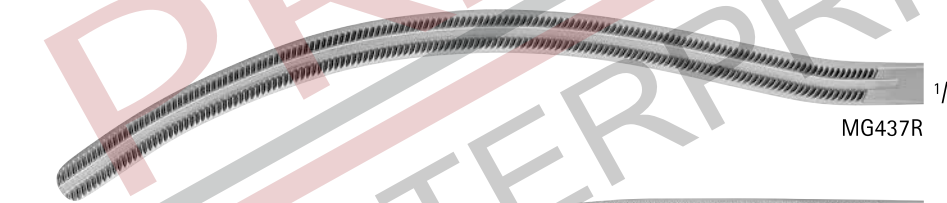

MG437R

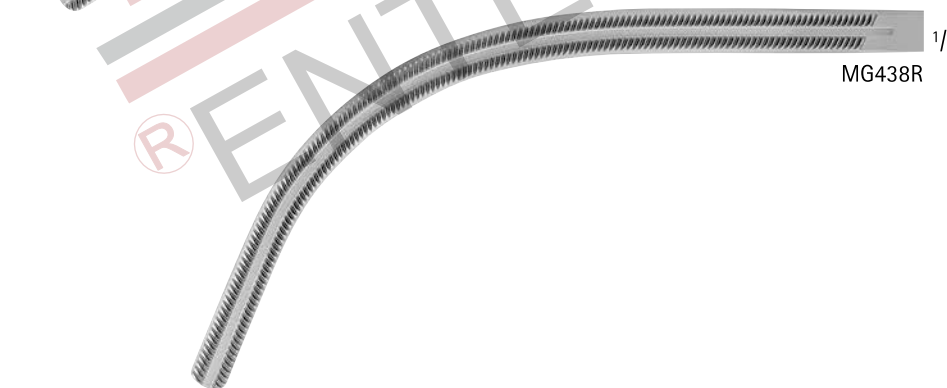

MG438R

GLASSMAN Gastroenterostomy Clamp

Catalog Number	Jaw	Jaw Length (mm)	Length (in.)
MG433R	STR	116	11 1/2
MG434R	ANG	115	11 1/2

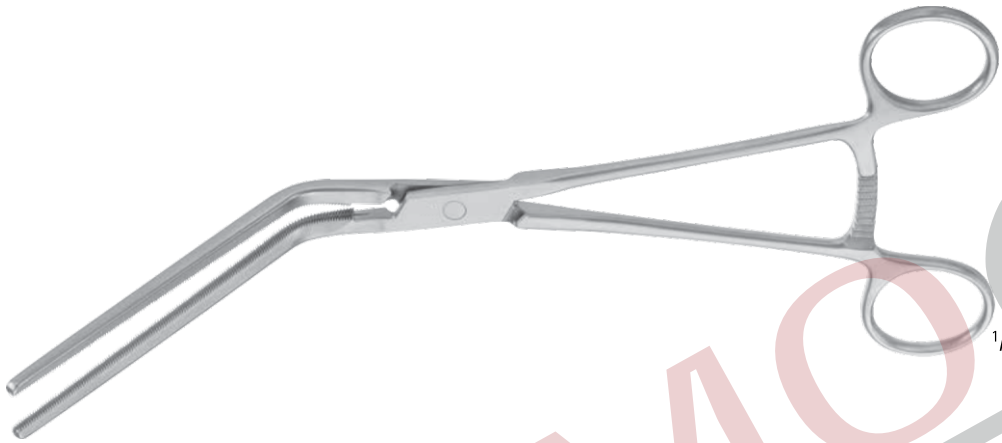

MG433R-MG434R



MG433R

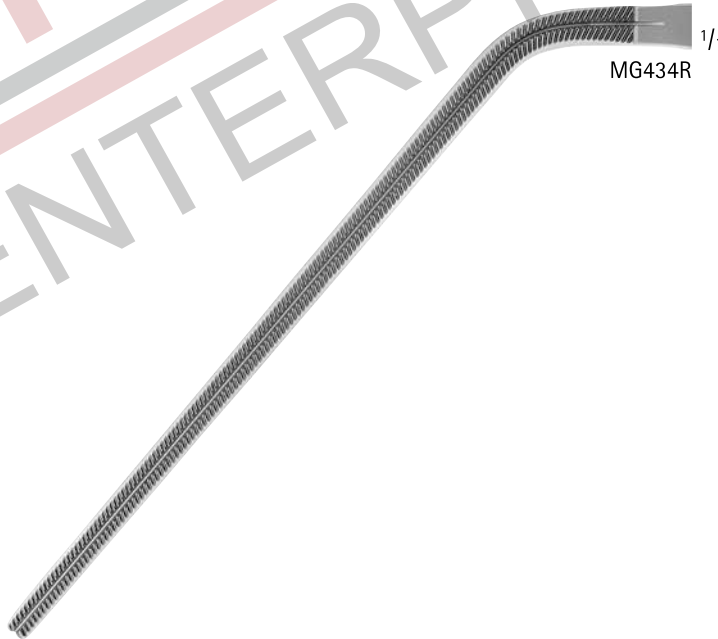

MG434R

**GLASSMAN Gastrointestinal Clamp,
 Non-Crushing**

Catalog Number	Jaw	Length (in.)
MB138R	STR	9 1/4
MB139R	ANG	9



MB138R-MB139R



MB138R

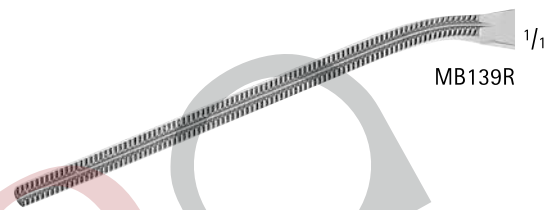

MB139R

LISTER Sponge Forceps

Catalog Number	Jaw	Length (in.)
BF004R	STR	5 1/4
BF006R	STR	6 1/4
BF008R	STR	7 1/4

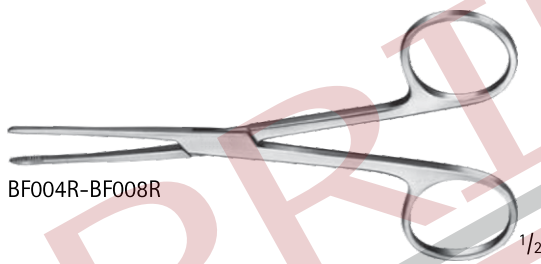

BF004R-BF008R

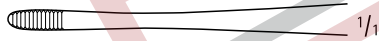

BF004R



BF006R

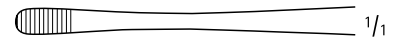

BF008R

GROSS Forceps, W/ Ratchet

Catalog Number	Jaw	Length (in.)
BF046R	STR	7 7/8
BF047R	CVD	7 7/8



BF046R-BF047R



BF046R

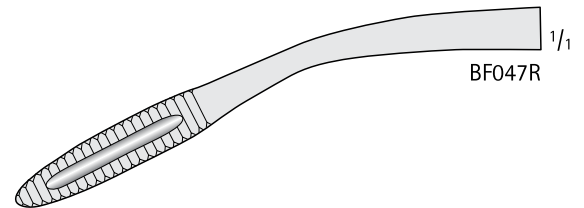

BF047R



BF078R

BF078R

SIMS-MAIER Sponge Forceps

Catalog Number	Jaw	Length (in.)
BF078R	STR	13 3/4

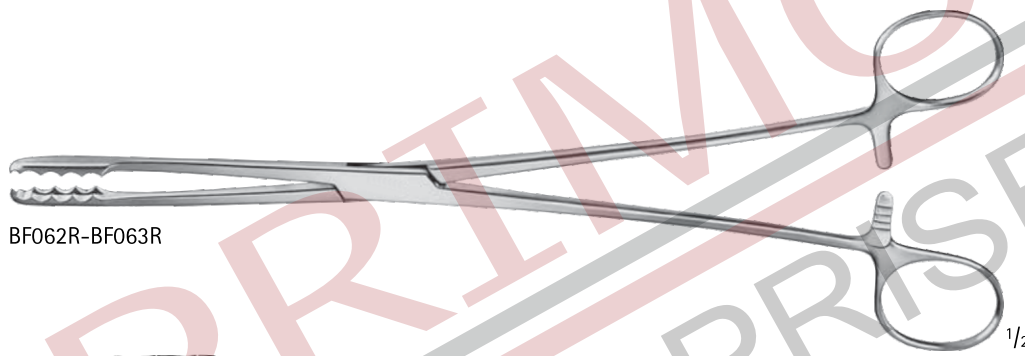

BF062R-BF063R

BF062R

BF063R

ULRICH-AESCALAP Sponge Forceps

Catalog Number	Jaw	Length (in.)
BF062R	STR	10 1/2
BF063R	CVD	10 1/2
BF065R	CVD	13 3/4



BF065R

BF065R



BF116R-BF118R

RAMPLEY Sponge Forceps

Catalog Number	Tip	Jaw	Length (in.)
BF116R	SERR	STR	7
BF118R	SERR	STR	9 3/4

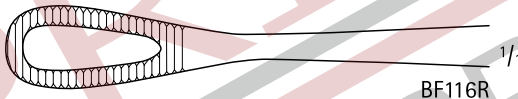

BF116R

1/1

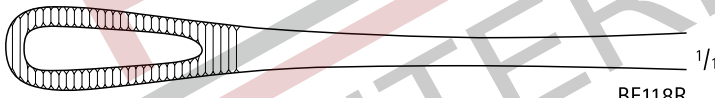

BF118R

1/1

FOERSTER Sponge Forceps

Catalog Number	Tip	Jaw	Length (in.)
MB098R	SERR	STR	12
MB099R	SERR	STR	14
MB904R	SERR	STR	16

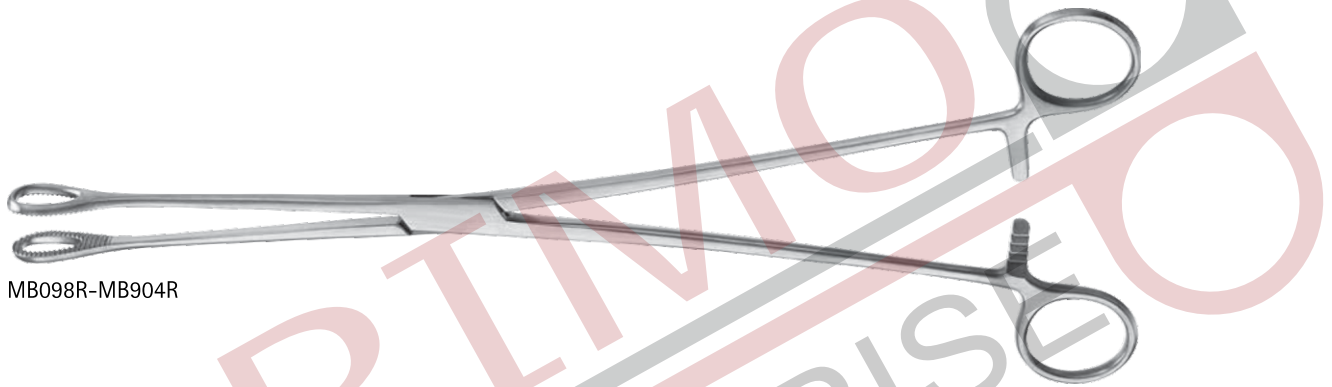

MB098R-MB904R



MB098R



MB099R



MB904R

FOERSTER-BALLENGER Sponge Forceps

Catalog Number	Tip	Jaw	Length (in.)
BF112R	SERR	STR	7
BF120R	SMOOTH	STR	9 5/8
BF122R	SERR	STR	9 5/8
BF113R	SERR	CVD	7
BF121R	SMOOTH	CVD	9 5/8
BF123R	SERR	CVD	9 5/8



BF112R-BF113R



BF120R-BF123R

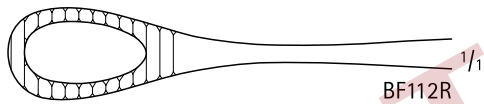

BF112R



BF120R



BF122R

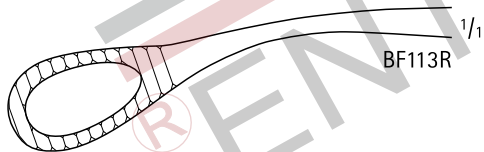

BF113R



BF121R

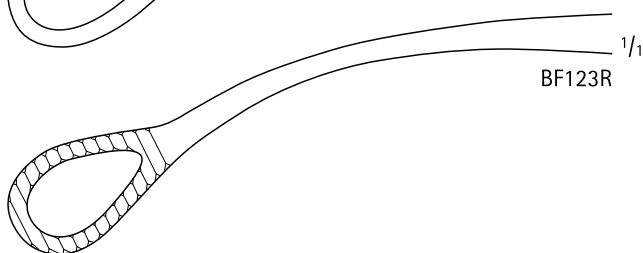

BF123R

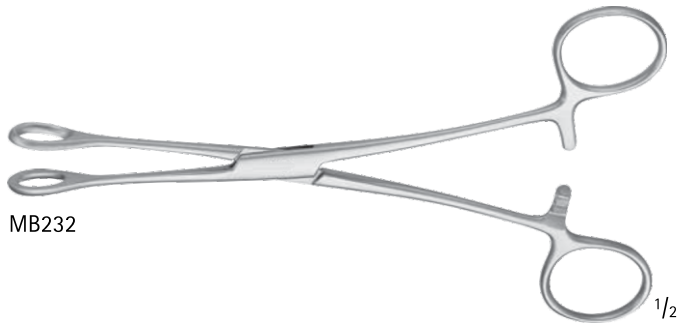

MB232

1/2

BALLENGER Sponge Forceps

Catalog Number	Tip	Jaw	Length (in.)
MB232	SMOOTH	STR	7



MB232

KELLY Sponge Forceps

Catalog Number	Tip	Jaw	Handle	Length (in.)
BF135R	SERR	CVD	W/ OUT RATCHET	12 1/2
BF136R	SERR	CVD	W/ RATCHET	12 1/2

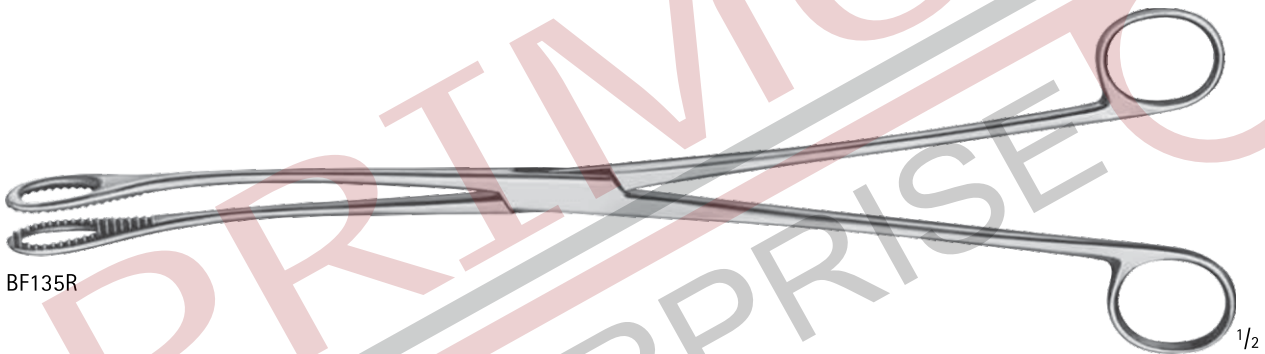

BF135R

1/2



BF136R

1/2

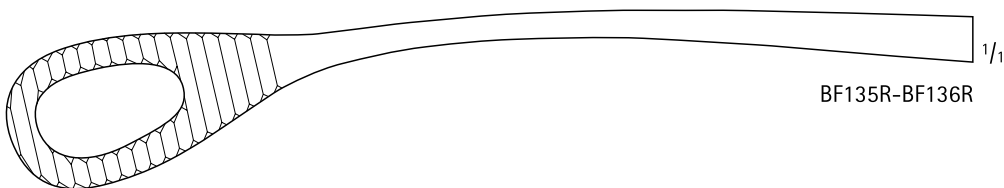

BF135R-BF136R

1/1

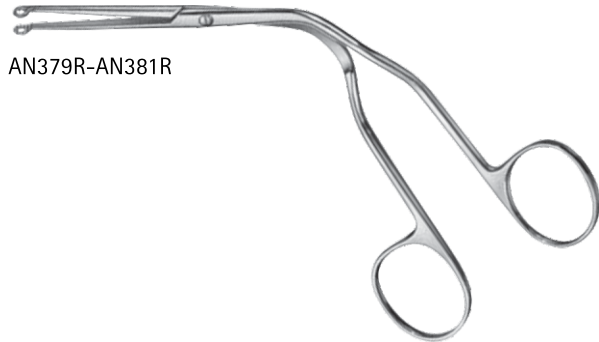

AN379R-AN381R

MAGILL Forceps

Catalog Number	Size	Length (in.)
AN379R	INFANT	6
AN380R	PEDIATRIC	7 7/8
AN381R	ADULT	9 3/4



AN379R



AN380R



AN381R

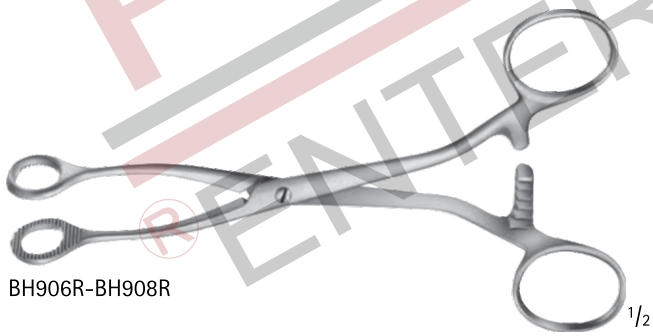

BH906R-BH908R

COLLIN Forceps W/ Ratchet

Catalog Number	Jaw	Length (in.)
BH906R	OVAL	6 1/4
BH908R	TEARDROP	6 1/4

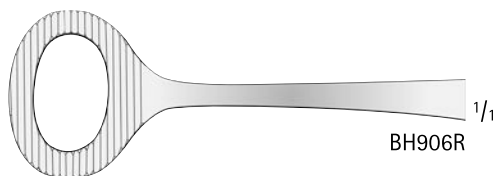

BH906R

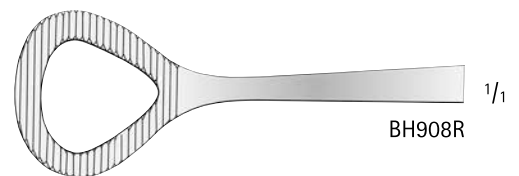

BH908R

HEYWOOD-SMITH Forceps

Catalog Number	Tip	Length (in.)
AN710R	SERR	7 7/8
AN711R	SERR	8 1/4

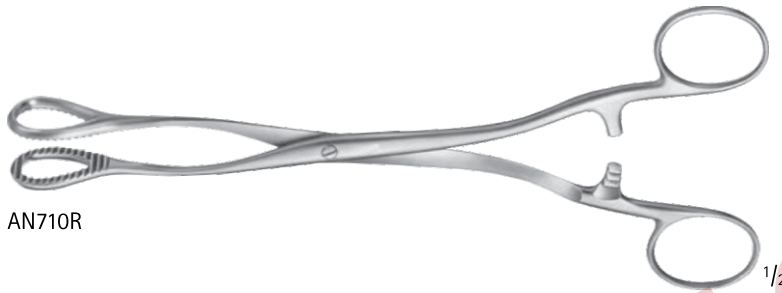

AN710R

1/2

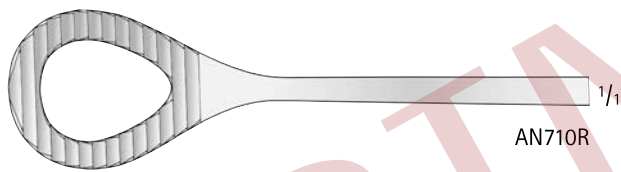

AN710R

1/1

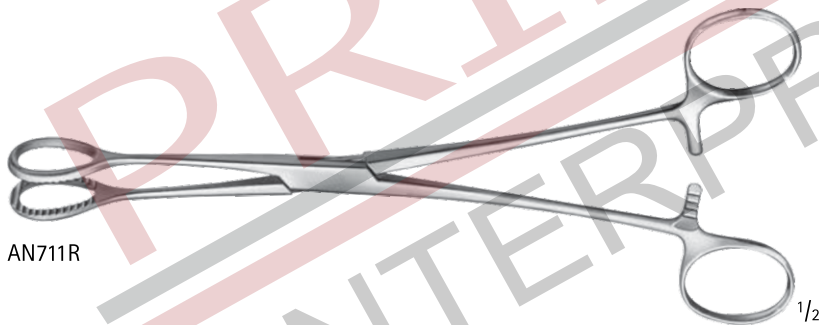

AN711R

1/2

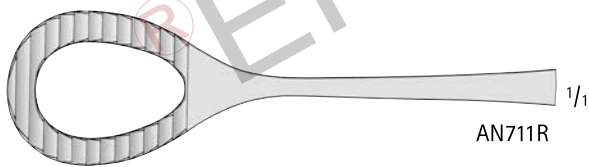

AN711R

1/1

YEOMAN Rectal Biopsy Forceps

Catalog Number	Tip Size (mm)	Shaft Length (in.)
EA903R	4	16 1/2

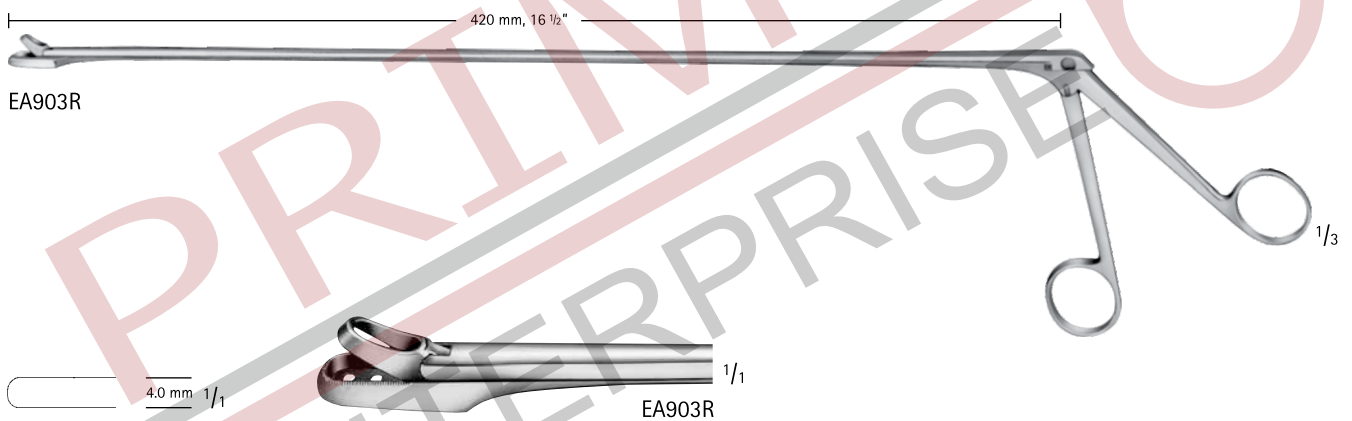



BH332R-BH339R



BH332R

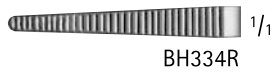

BH334R



BH336R

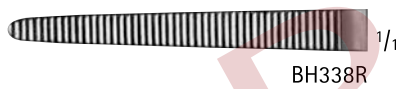

BH338R

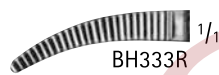

BH333R



BH335R

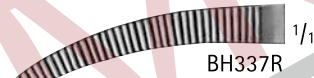

BH337R



BH339R

SPENCER-WELLS Forceps

Catalog Number	Jaw	Length (in.)
BH332R	STR	5 1/8
BH334R	STR	6
BH336R	STR	6 7/8
BH338R	STR	7 7/8
BH333R	CVD	5 1/8
BH335R	CVD	6
BH337R	CVD	6 7/8
BH339R	CVD	7 7/8

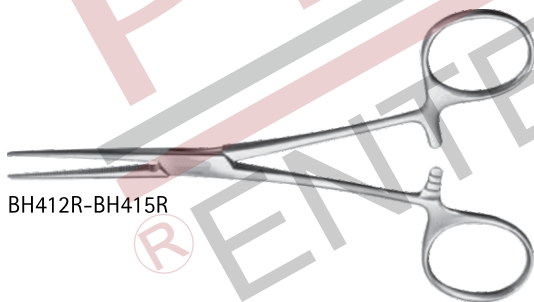

BH412R-BH415R



BH412R



BH414R



BH413R



BH415R

PEAN Forceps, Delicate

Catalog Number	Jaw	Length (in.)
BH412R	STR	5 1/8
BH414R	STR	5 1/2
BH413R	CVD	5 1/8
BH415R	CVD	5 1/2

PEAN Forceps

Catalog Number	Jaw	Length (in.)
BH410R	STR	5
BH422R	STR	5 1/8
BH424R	STR	5 1/2
BH425R	CVD	5 1/2



BH410R



BH410R

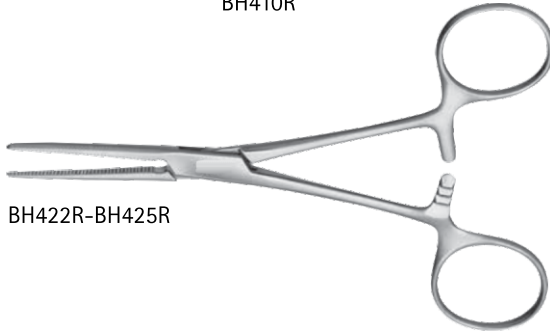

BH422R-BH425R



BH422R



BH424R



BH425R

PEAN Artery Forceps

Catalog Number	Jaw	Length (in.)
MB180R	CVD	12
MB181R	CVD	14



MB180R-MB181R

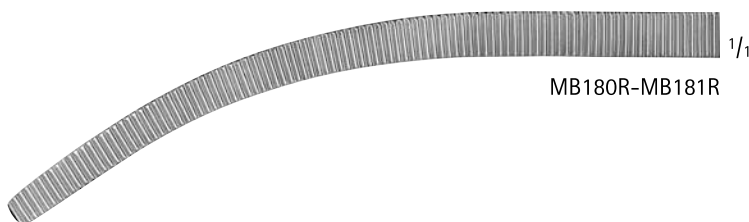

MB180R-MB181R

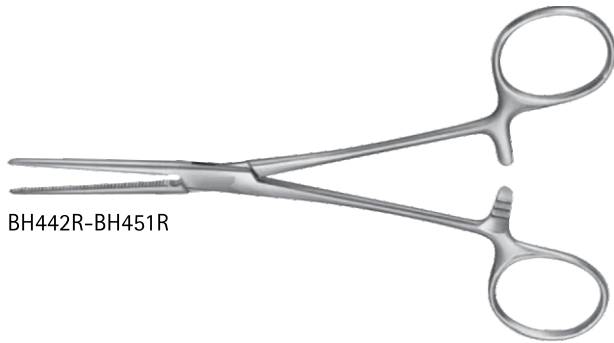

BH442R-BH451R

ROCHESTER-PEAN Forceps

Catalog Number	Jaw	Length (in.)
BH442R	STR	6 1/4
BH444R	STR	7 1/4
BH446R	STR	7 7/8
BH448R	STR	8 7/8
BH450R	STR	9 1/2
BH443R	CVD	6 1/4
BH445R	CVD	7 1/4
BH447R	CVD	7 7/8
BH449R	CVD	8 7/8
BH451R	CVD	9 1/2



BH442R

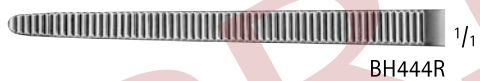

BH444R



BH446R



BH448R



BH450R

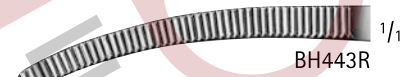

BH443R



BH445R



BH447R



BH449R



BH451R



BH470R-BH475R, MB128R

PEAN Forceps, Long

Catalog Number	Jaw	Length (in.)
BH470R	STR	9 1/2
BH472R	STR	10 1/4
BH474R	STR	11
MB128R	STR	12
BH471R	CVD	9 1/2
BH473R	CVD	10 1/4
BH475R	CVD	11



BH470R



BH472R



BH474R

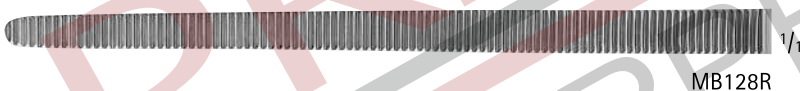

MB128R

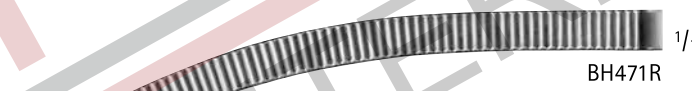

BH471R

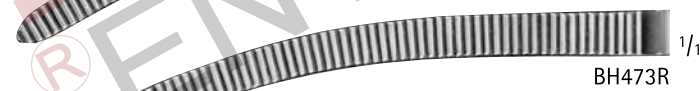

BH473R

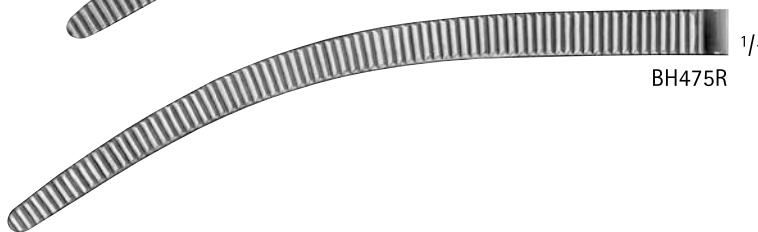

BH475R



BH614R-BH615R



BH614R



BH615R

KOCHER Forceps, Delicate

Catalog Number	Jaw	Teeth	Length (in.)
BH614R	STR	1 x 2	5 1/2
BH615R	CVD	1 x 2	5 1/2

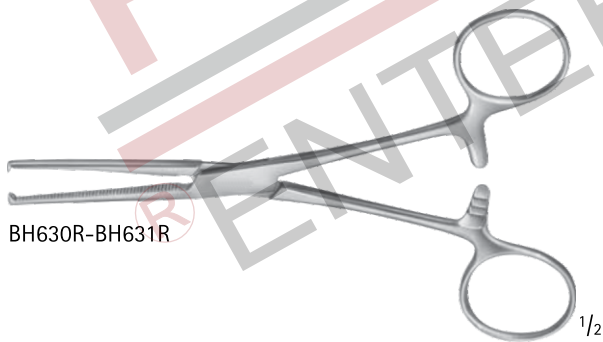

BH630R-BH631R



BH630R



BH631R

KOCHER Forceps

Catalog Number	Jaw	Teeth	Length (in.)
BH630R	STR	1 x 2	6
BH631R	CVD	1 x 2	6

ROCHESTER-OCHSNER Forceps

Catalog Number	Jaw	Teeth	Length (in.)
BH618R	STR	1 x 2	5 1/2
BH619R	CVD	1 x 2	5 1/2



BH618R-BH619R



BH618R



BH619R

ROCHESTER-OCHSNER Artery Forceps

Catalog Number	Jaw	Teeth	Length (in.)
MB172R	STR	1 x 2	14

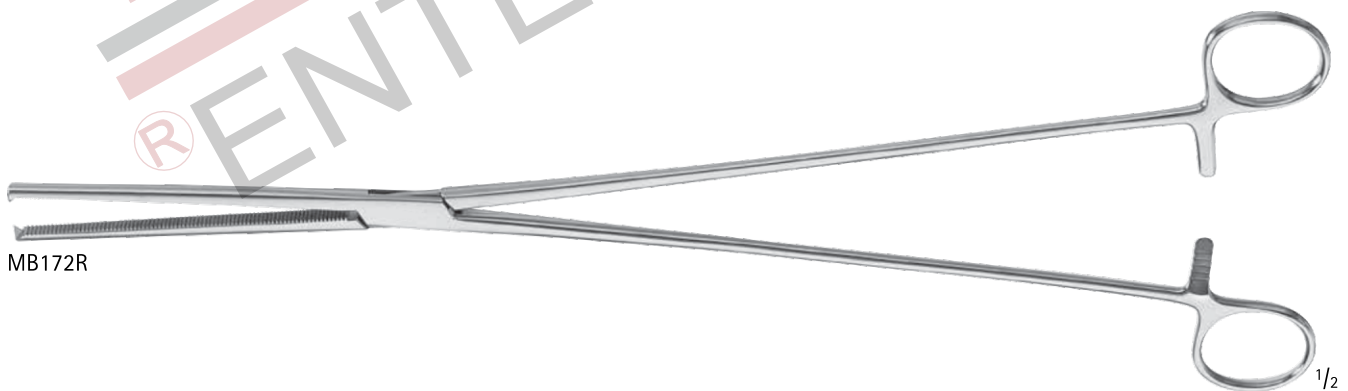

MB172R



MB172R

KOCHER-OCHSNER Forceps

Catalog Number	Jaw	Teeth	Length (in.)
BH642R	STR	1 x 2	6 1/4
BH644R	STR	1 x 2	7 1/4
BH646R	STR	1 x 2	7 7/8
BH648R	STR	1 x 2	8 7/8
BH650R	STR	1 x 2	9 1/2
BH652R	STR	1 x 2	10 1/4
BH654R	STR	1 x 2	11
BH643R	CVD	1 x 2	6 1/4
BH645R	CVD	1 x 2	7 1/4
BH647R	CVD	1 x 2	7 7/8
BH649R	CVD	1 x 2	8 7/8
BH651R	CVD	1 x 2	9 1/2
BH653R	CVD	1 x 2	10 1/4
BH655R	CVD	1 x 2	11



BH642R-BH655R



ROCHESTER-OCHSNER Forceps

Catalog Number	Jaw	Teeth	Length (in.)
MB807R	STR	1 x 2	14
MB909R	STR	1 x 2	16
MB908R	CVD	1 x 2	13 3/4

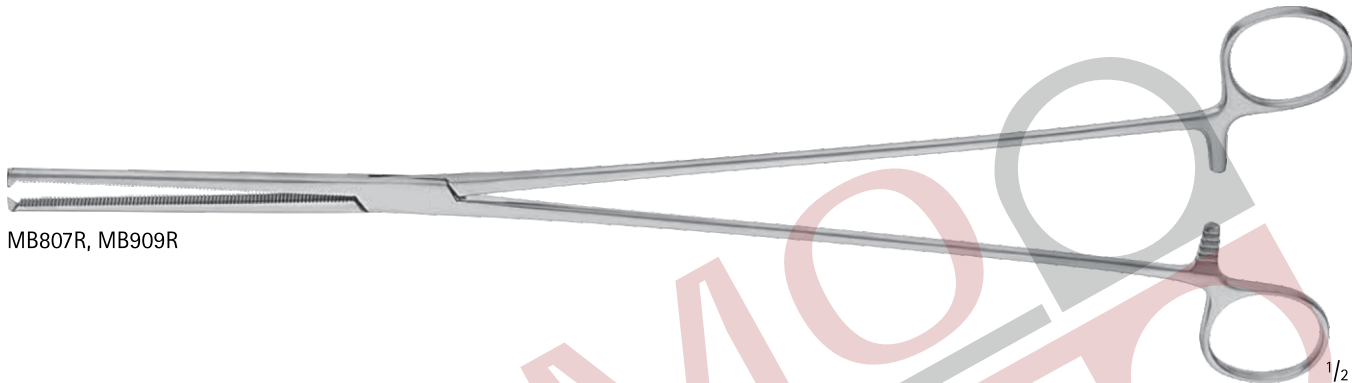

MB807R, MB909R

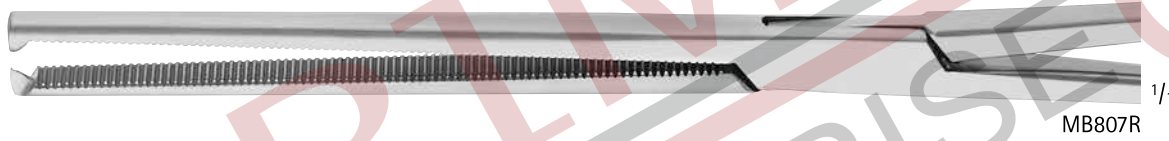

MB807R

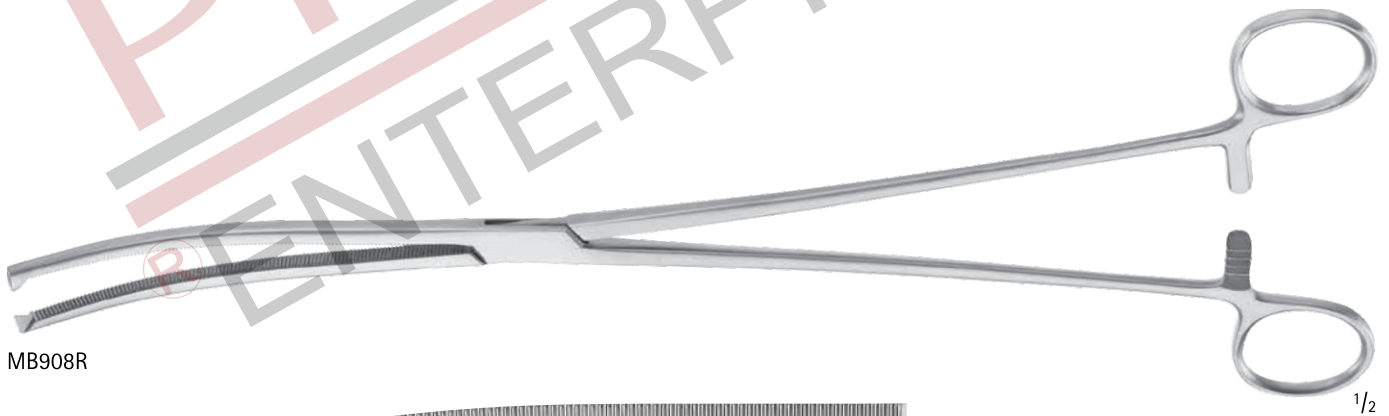

MB908R

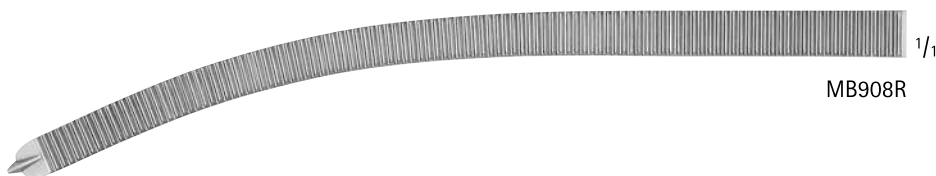

MB908R

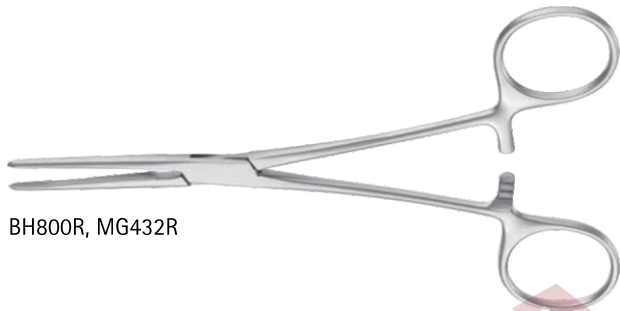

BH800R, MG432R

ROCHESTER-CARMALT Forceps

Catalog Number	Jaw	Length (in.)
BH800R	STR	6 1/4
BH804R	STR	7 7/8
MG196R	STR	9
MG431R	STR	10 1/4
BH801R	CVD	6 1/4
BH805R	CVD	7 7/8
MG197R	CVD	9
MG432R	CVD	10 1/4



BH800R



BH804R



MG196R

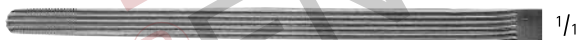

MG431R



BH801R



BH805R

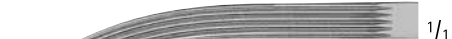

MG197R



MG432R

JONES Hemostatic Forceps

Catalog Number	Jaw	Length (in.)
MG426R	STR	5



MOYNIHAN Forceps

Catalog Number	Jaw	Length (in.)
BH831R	CVD	9
BH833R	CVD	9 1/2

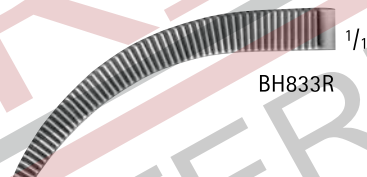
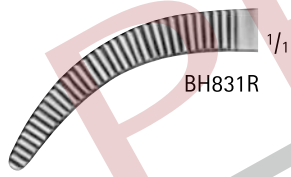
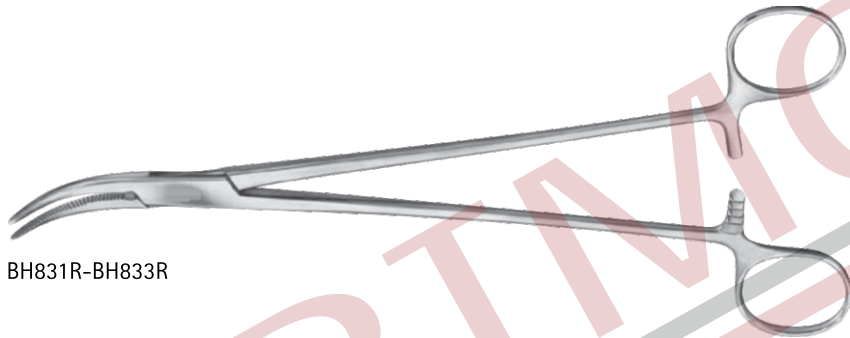

NEGUS Tonsil Forceps

Catalog Number	Jaw	Length (in.)
BH951R	HEAVY-CVD	7 1/2
BH952R	U-CVD	7 1/2

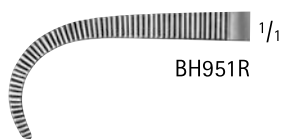
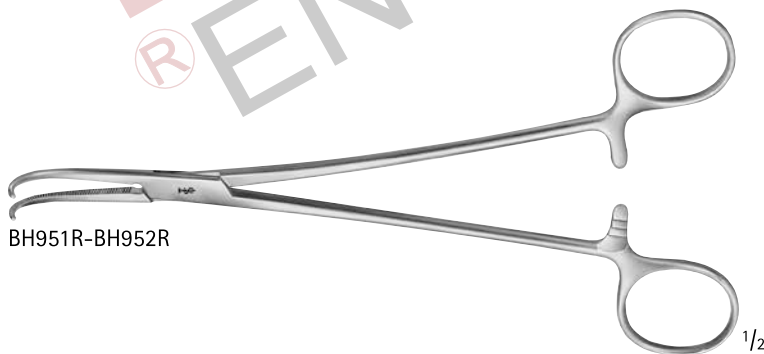

CARMALT Artery Forceps, Longitudinal Serrations

Catalog Number	Jaw	Length (in.)
MB182R	SLIGHT-CVD	12



MB182R



MB182R



MA172R, BH961R, BH963R

SCHNIDT Tonsil Clamp

Catalog Number	Ring Handle	Jaw	Length (in.)
MA172R	OPEN RING	STR	7 1/2
BH961R	OPEN-RING	SLIGHT-CVD	7 1/4
BH963R	OPEN-RING	CVD	7 1/4
BH957R	CLOSED-RING	SLIGHT-CVD	7 1/4
BH959R	CLOSED-RING	CVD	7 1/4

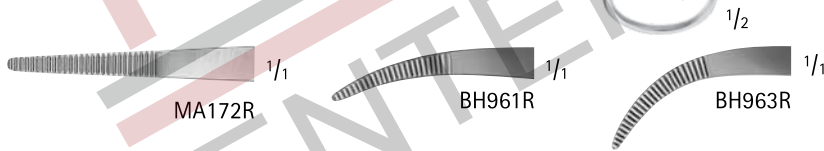

MA172R

BH961R

BH963R



BH957R, BH959R



BH957R

BH959R

OCHSNER-DIXON Artery Forceps

Catalog Number	Jaw	Teeth	Length (in.)
MD450	STR	1 x 2	6 1/4



MD450

1/2



MD450

Baby HARTMANN Mosquito Artery Forceps

Catalog Number	Jaw	Teeth	Length (in.)
BH104R	STR	-	4
BH114R	STR	1 x 2	4
BH105R	CVD	-	4
BH115R	CVD	1 x 2	4



BH104R-BH115R

1/2



BH104R



BH105R



BH114R



BH115R

Micro HALSTED Mosquito Forceps, Delicate

Catalog Number	Jaw	Teeth	Length (in.)
BH108R	STR	-	5
BH118R	STR	1 x 2	5
BH109R	CVD	-	5
BH119R	CVD	1 x 2	5

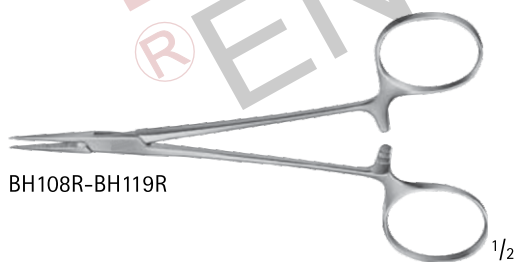

BH108R-BH119R

1/2



BH108R



BH109R



BH118R



BH119R

Mosquito Forceps

Catalog Number	Jaw	Length (in.)
MG085R	DEL, CVD.	6

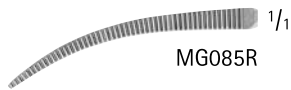
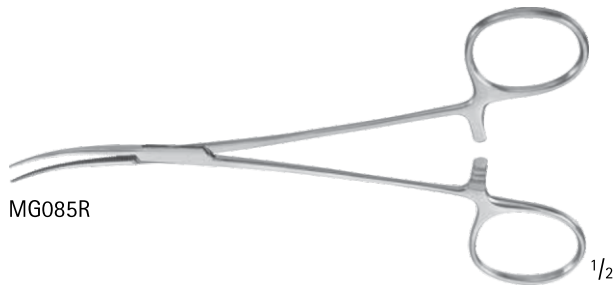

Suture Forceps

Catalog Number	Tip	Jaw	Length (in.)
BJ002R	SMOOTH	STR	3 3/4

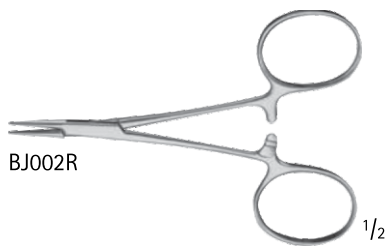

JACOBSON Hemostatic Forceps

Catalog Number	Jaw	Length (in.)
BH187R	SLIGHT-CVD	7 1/2
BH189R	HEAVY-CVD	7 1/2

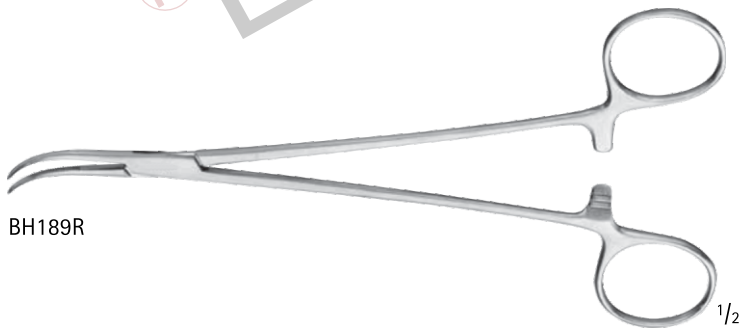
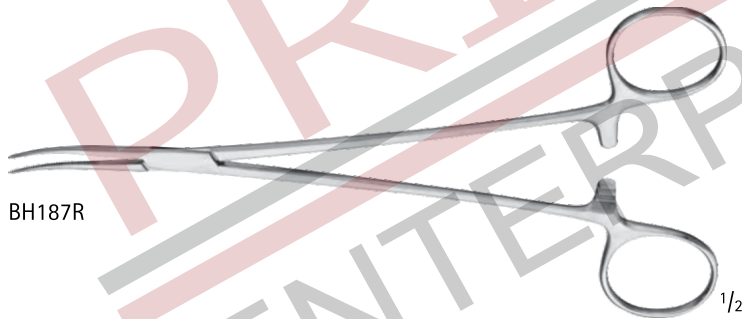

ADSON Hemostatic Forceps

Catalog Number	Jaw	Length (in.)
BH205R	CVD	8 1/2

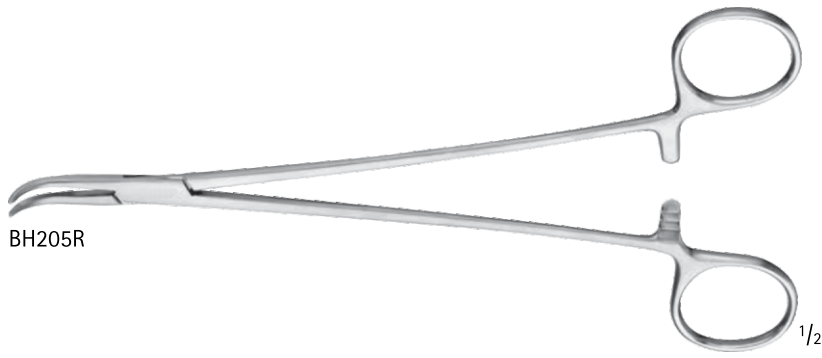

BH205R

1/2



BH205R

HALSTED Forceps Delicate

Catalog Number	Jaw	Teeth	Length (in.)
BH202R	STR	-	7 1/4
BH212R	STR	1 x 2	7 1/4
BH203R	CVD	-	7 1/4
BH213R	CVD	1 x 2	7 1/4



BH202R-BH213R

1/2



BH202R

1/1

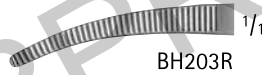

BH203R

1/1



BH212R

1/1

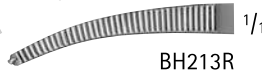

BH213R

1/1

PROVIDENCE Hospital Forceps, Delicate

Catalog Number	Jaw	Length (in.)
BH130R	STR	5 1/2
BH131R	CVD	5 1/2

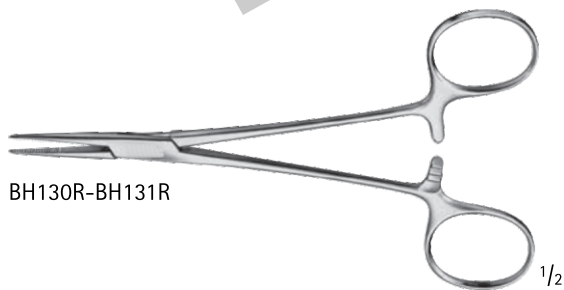

BH130R-BH131R

1/2



BH130R

1/1



BH131R

1/1

KELLY Forceps

Catalog Number	Jaw	Length (in.)
BH134R	STR	5 1/2
BH135R	CVD	5 1/2

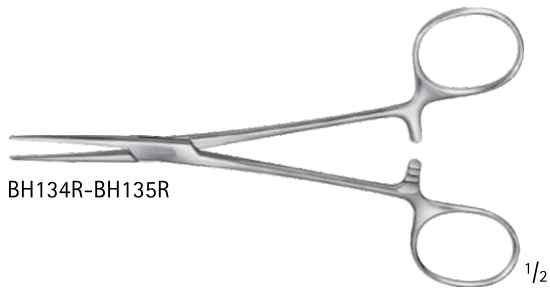

BH134R-BH135R



BH134R



BH135R

Baby CRILE Forceps

Catalog Number	Jaw	Teeth	Length (in.)
BH140R	STR	-	5 1/2
BH150R	STR	1 x 2	5 1/2
BH141R	CVD	-	5 1/2
BH151R	CVD	1 x 2	5 1/2

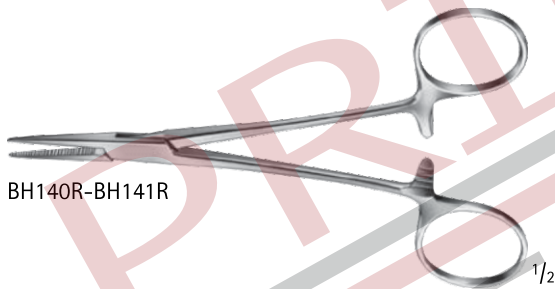

BH140R-BH141R



BH140R

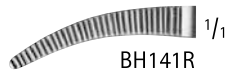

BH141R

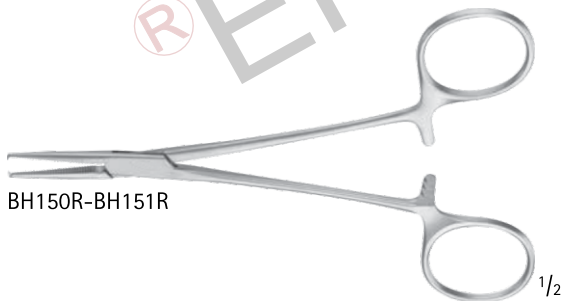

BH150R-BH151R



BH150R



BH151R



BH144R-BH155R

CRILE Forceps

Catalog Number	Jaw	Teeth	Length (in.)
BH144R	STR	-	5 1/2
BH154R	STR	1 x 2	5 1/2
BH166R	STR	-	6 1/4
BH176R	STR	1 x 2	6 1/4
BH145R	CVD	-	5 1/2
BH155R	CVD	1 x 2	5 1/2
BH167R	CVD	-	6 1/4
BH177R	CVD	1 x 2	6 1/4

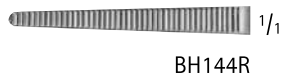

BH144R

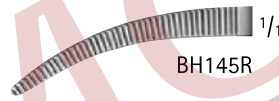

BH145R



BH154R



BH155R

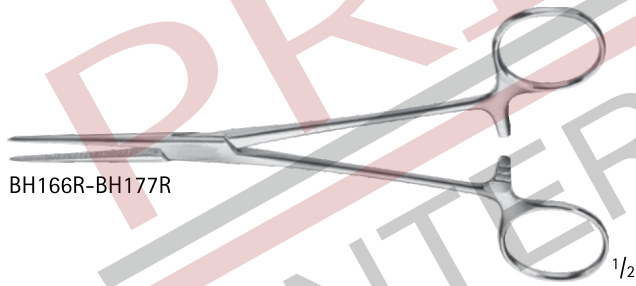

BH166R-BH177R



BH166R



BH167R



BH176R



BH177R

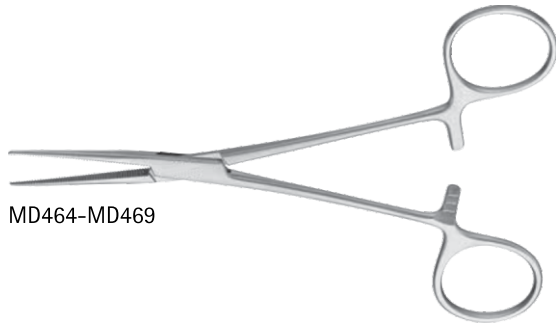

MD464-MD469

COLLER Artery Forceps

Catalog Number	Jaw	Length (in.)
MD464	STR	5 3/4
MD466R	STR	6 1/2
MD468	STR	7
MD465R	CVD	5 3/4
MD467R	CVD	6 1/2
MD469	CVD	7



MD464



MD466R



MD468



MD465R



MD467R

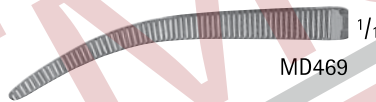

MD469



BH160R-BH171R

LERICHE Forceps, Delicate

Catalog Number	Jaw	Teeth	Length (in.)
BH160R	STR	-	6
BH170R	STR	1 x 2	6
BH161R	CVD	-	6
BH171R	CVD	1 x 2	6



BH160R



BH170R

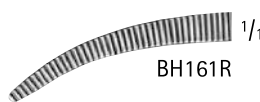

BH161R



BH171R

RANKIN Forceps, Delicate

Catalog Number	Jaw	Length (in.)
BH164R	STR	6 1/4
BH165R	CVD	6 1/4

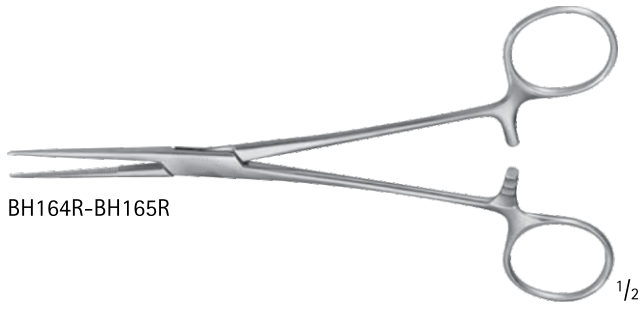

BH164R-BH165R

1/2



BH164R

1/1



BH165R

1/1

BIRKETT Hemostatic Forceps

Catalog Number	Jaw	Length (in.)
BH197R	CVD	7 1/4

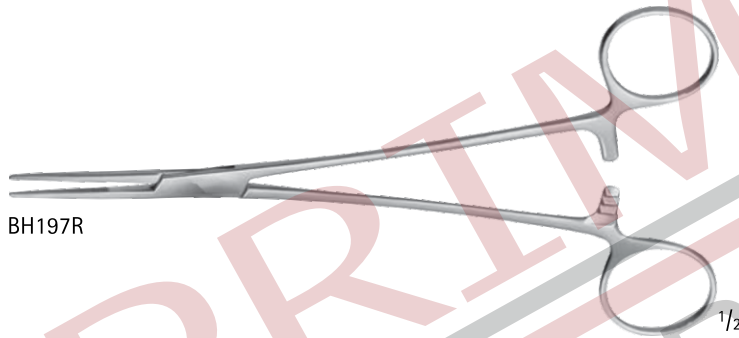

BH197R

1/2



BH197R

1/1

NISSEN Tonsil Forceps, Delicate

Catalog Number	Jaw	Length (in.)
BH199R	CVD	7 1/4

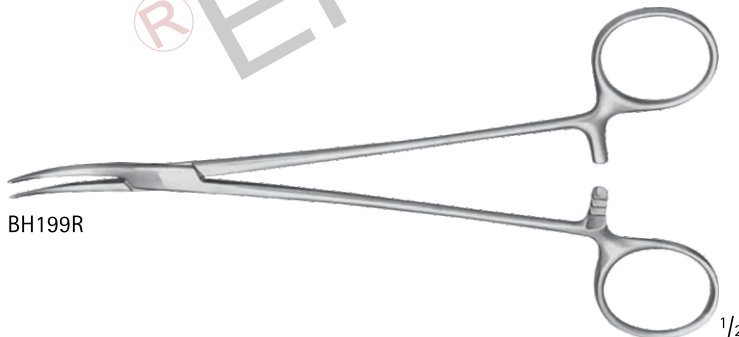

BH199R

1/2

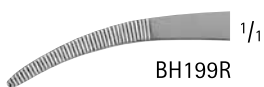

BH199R

1/1



BH200R-BH201R



BH200R



BH201R

ADSON Tonsil Forceps, Delicate

Catalog Number	Jaw	Length (in.)
BH200R	STR	7 1/4
BH201R	CVD	7 1/4



BH206R-BH217R



BH206R



BH207R



BH216R



BH217R



BH209R

HEISS Forceps, Delicate

Catalog Number	Jaw	Teeth	Length (in.)
BH206R	STR	-	7 7/8
BH216R	STR	1 x 2	7 7/8
BH207R	CVD	-	7 7/8
BH217R	CVD	1 x 2	7 7/8
BH209R	HVY-CVD	-	7 3/4

GEMINI Right Angle Forceps

Catalog Number	Length (in.)
BJ100R	5 1/2
BJ102R	7
BJ103R	7 7/8
BJ104R	9
BJ106R	11

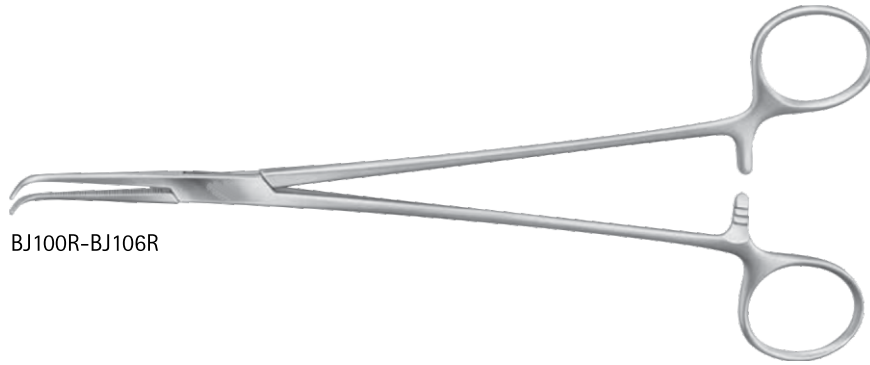

BJ100R-BJ106R

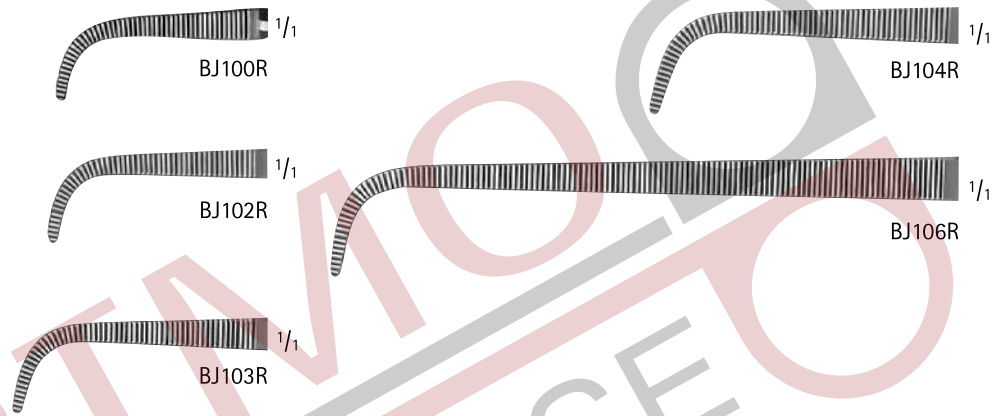

HOLLE Forceps, Delicate

Catalog Number	Length (in.)
BJ037R	5 3/4
BJ038R	7 1/4
BJ039R	9 1/4



BJ037R-BJ039R

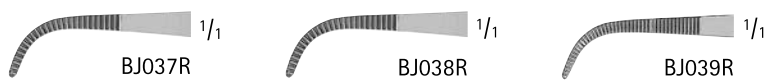

KANTROWITZ Right Angle Forceps

Catalog Number	Length (in.)
MB058R	6 3/8
BJ057R	7 7/8
BJ058R	9 5/8
BJ059R	10 3/4
MB061R	12

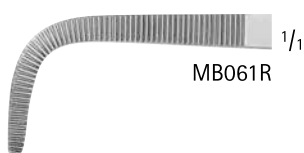
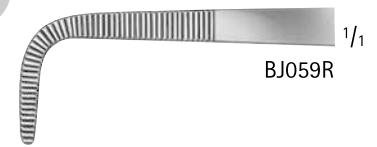
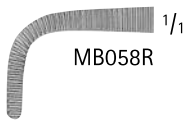

Baby ADSON Forceps

Catalog Number	Length (in.)
BJ013R	5 1/2
BJ014R	7

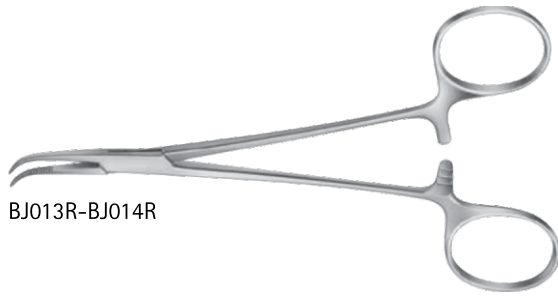

BJ013R-BJ014R



BJ013R



BJ014R

Micro ADSON Suture Forceps

Catalog Number	Length (in.)
BJ008R	5 1/2



BJ008R



BJ008R

MIXTER (MEEKER) Right Angle Forceps

Catalog Number	Length (in.)
MD569	5 1/2
MD570R	7

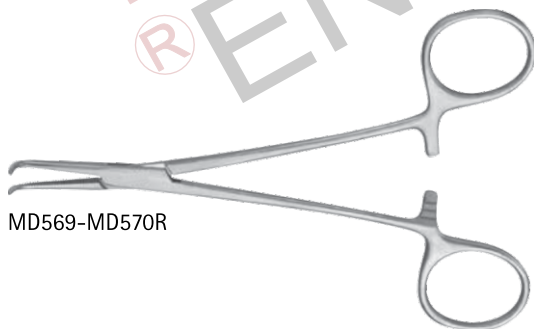

MD569-MD570R

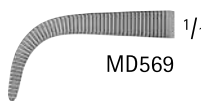

MD569



MD570R



BJ020R-BJ035R

OVERHOLT-GEISSENDOERFER Forceps

Catalog Number	Jaw Curve (#)	Length (in.)
BJ020R	0	7 3/4
BJ021R	1	8
BJ022R	2	8 3/4
BJ023R	3	8 7/8
BJ024R	4	8 3/4
BJ025R	5	9
BJ026R	6	8 7/8
BJ031R	1	10 1/4
BJ032R	2	10 5/8
BJ033R	3	10 3/4
BJ034R	4	10 5/8
BJ035R	5	11



BJ020R

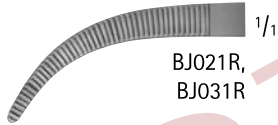

BJ021R,
BJ031R

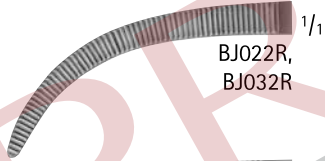

BJ022R,
BJ032R

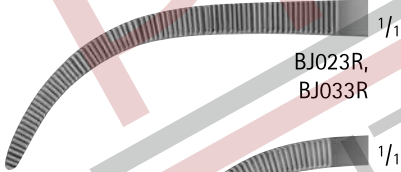

BJ023R,
BJ033R

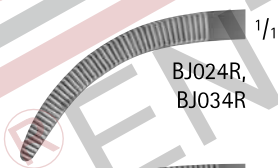

BJ024R,
BJ034R

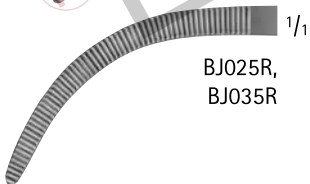

BJ025R,
BJ035R



BJ026R

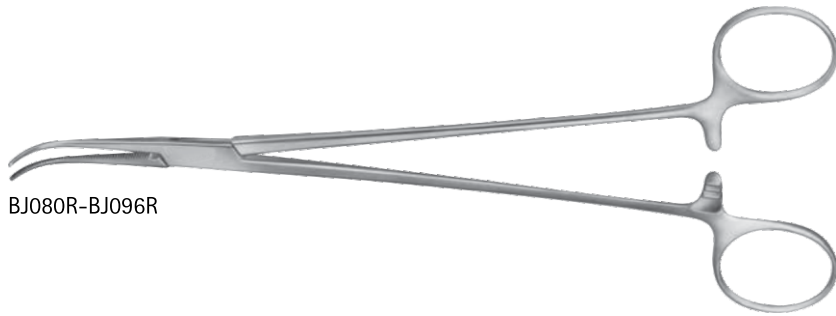

OVERHOLT Forceps

Catalog Number	Jaw Curve (#)	Length (in.)
BJO80R	0	8 1/2
BJO81R	1	8 1/4
BJO82R	2	8 3/4
BJO83R	3	8 7/8
BJO86R	6	8 7/8
BJO90R	0	11 5/8
BJO91R	1	11 5/8
BJO96R	6	11 3/4

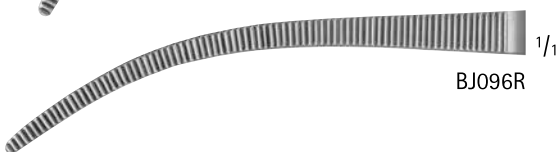
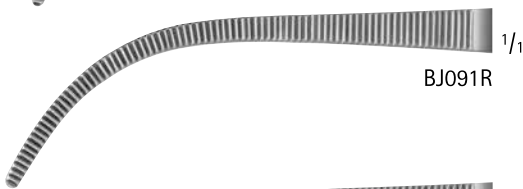
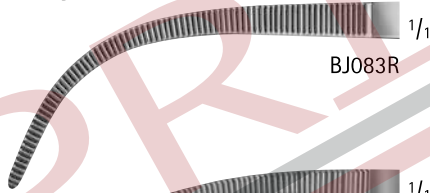
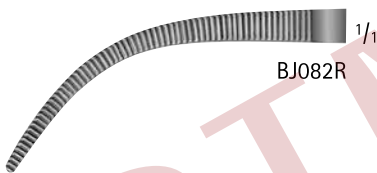
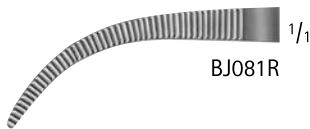

MEEKER Forceps

Catalog Number	Length (in.)
MB459R	11

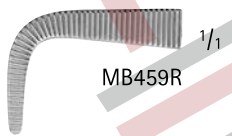
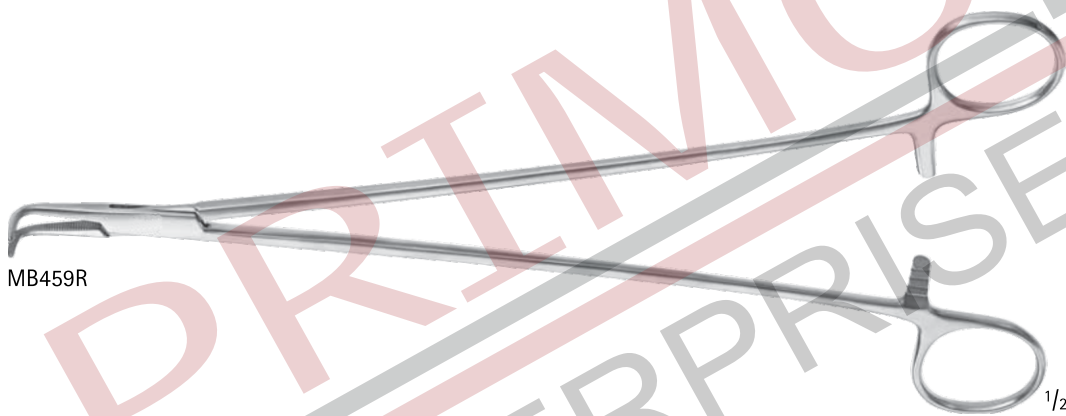

ZENKER Ligature Forceps

Catalog Number	Jaw	Length (in.)
BJ047R	SLIGHT-CVD	11 3/4
BJ048R	HEAVY-CVD	11 1/2
BJ130R	SLIGHT-CVD	13 3/4
BJ131R	CVD	13 3/4
BJ132R	HEAVY-CVD	13 3/4

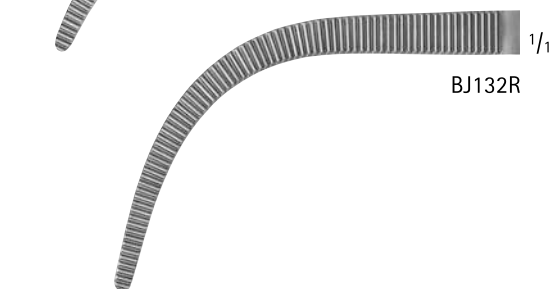
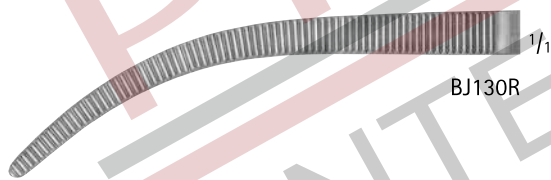
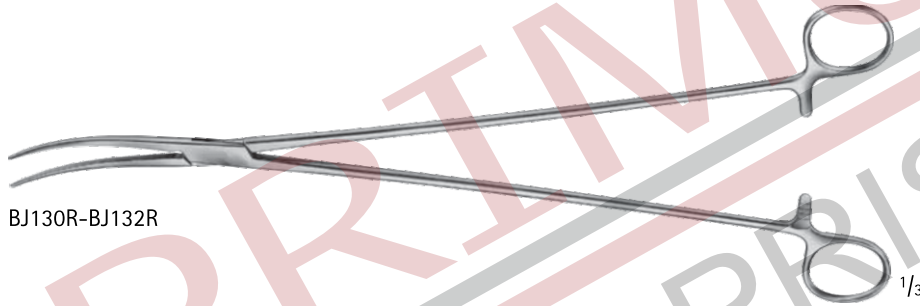
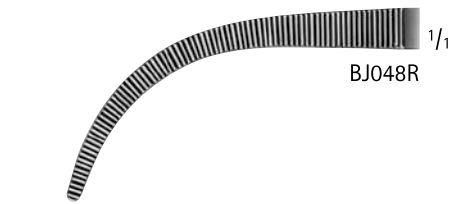

**MIXTER Forceps, Longitudinal
Serrations**

Catalog Number	Length (in.)
BJ061R	8 3/4
BJ062R	9 3/4
BJ073R	11 1/2



BJ061R-BJ062R



BJ061R



BJ062R

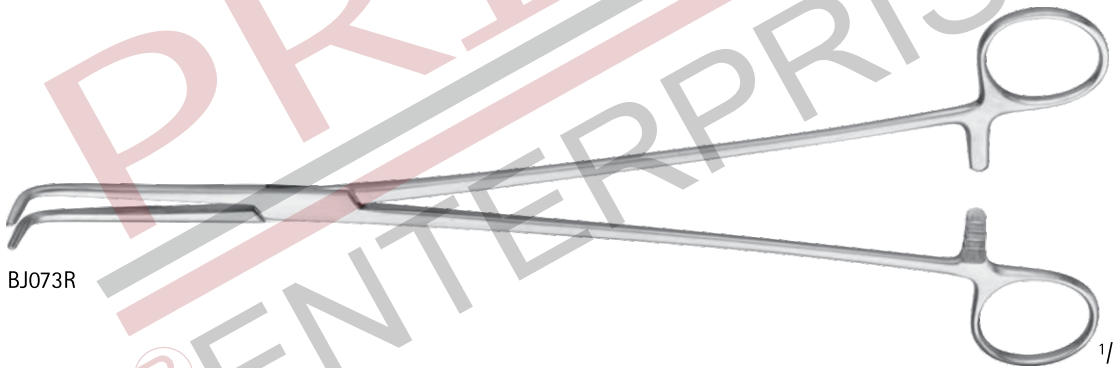

BJ073R

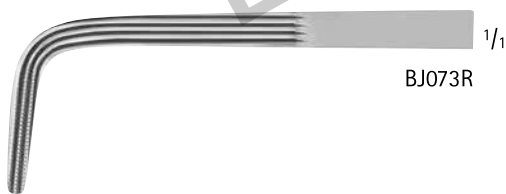

BJ073R

MIXTER Forceps

Catalog Number	Length (in.)
BJ055R	9
MB808R	14
MB924R	15 3/4



BJ055R

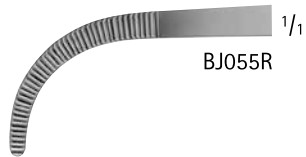

BJ055R

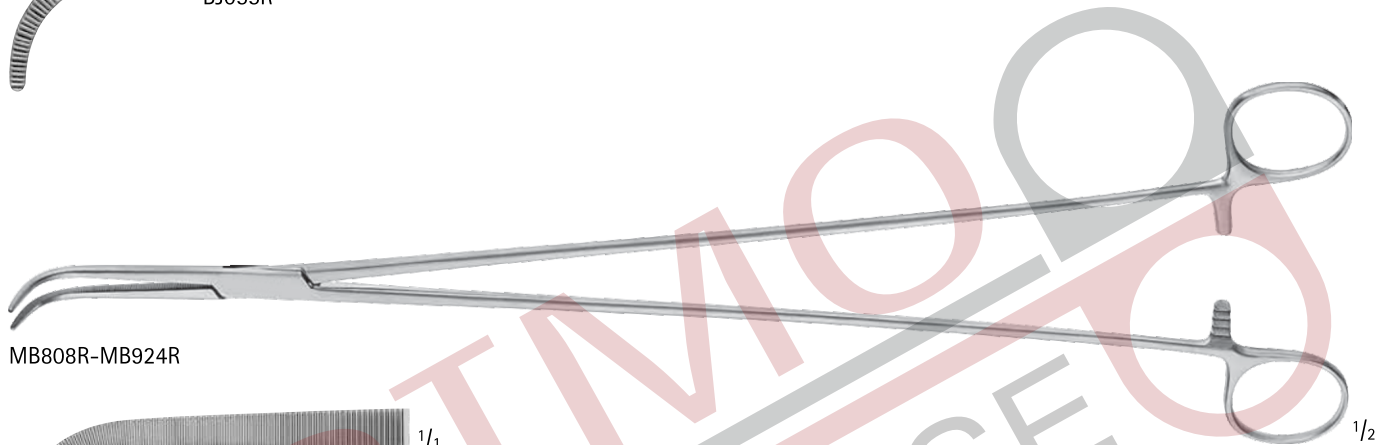

MB808R-MB924R



MB808R

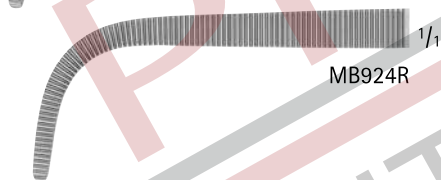

MB924R

Baby MIXTER Forceps

Catalog Number	Length (in.)
BJ011R	5 1/2
BJ012R	7



BJ011R-BJ012R



BJ011R



BJ012R

WIKSTROEM Forceps

Catalog Number	Length (in.)
BJ051R	8

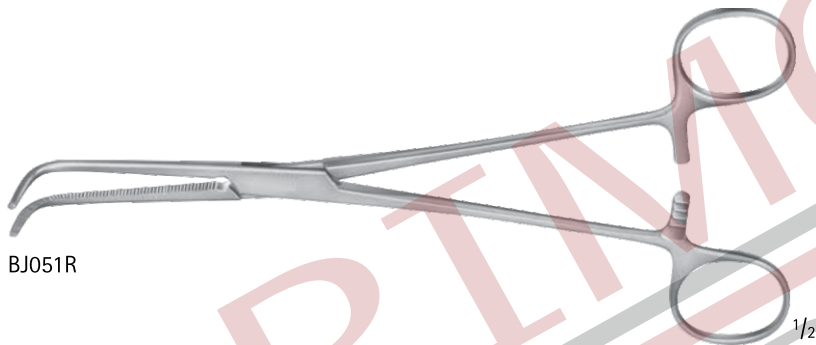

BJ051R

1/2

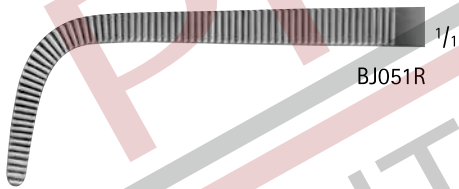

1/1

BJ051R

LAWRENCE Forceps

Catalog Number	Length (in.)
BJ070R	10 5/8

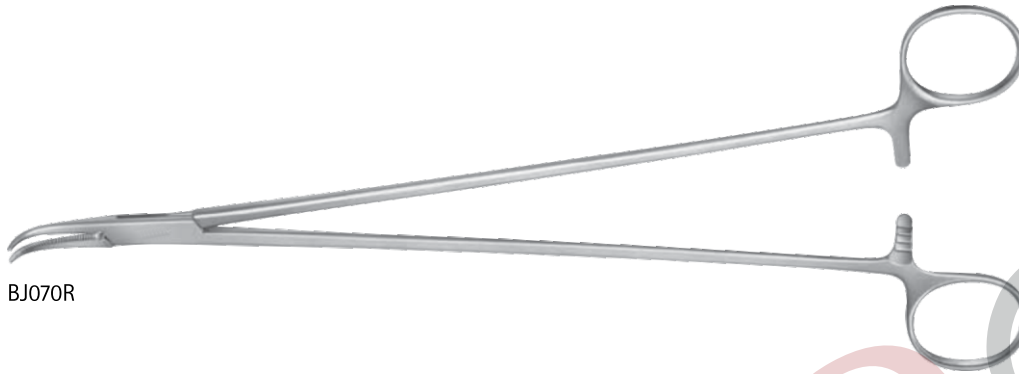

BJ070R

1/2



1/1
BJ070R

REINHOFF Swan Neck Clamp

Catalog Number	Tip	Jaw	Handle	Length (in.)
US116	SERR	CVD	CVD	10 1/4



US116

1/2

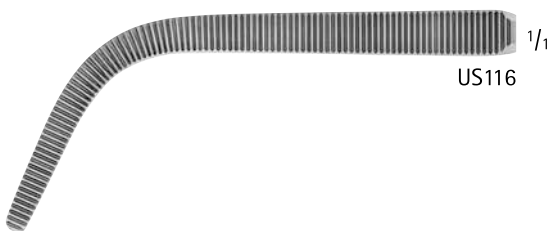

1/1
US116

KIEBACK Forceps

Catalog Number	Jaw	Length (in.)
BJ075R	CVD, LONGITUDINAL SERR	9 1/4



BJ075R



BJ075R

COLLIER-ANDERSON Forceps

Catalog Number	Jaw	Length (in.)
MB897R	CVD, LONGITUDINAL SERR	10
MB898R	CVD, LONGITUDINAL SERR	11



MB897R-MB898R



MB897R-MB898R

DEBAKEY-COLLIER Forceps

Catalog Number	Jaw	Length (in.)
MB899R	CVD, SERR	8



MB899R



MB899R



BF407R

JONES Towel Clamp

Catalog Number	Length (in.)
BF407R	3 1/4

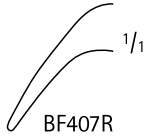

BF407R



BF426R

BERNHARD Towel Clamp

Catalog Number	Length (in.)
BF426R	6 1/4

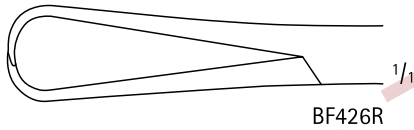

BF426R



BF431R-BF433R

BACKHAUS Towel Clamp

Catalog Number	Length (in.)
BF431R	3 1/2
BF432R	4 1/4
BF433R	5 1/4



BF431R

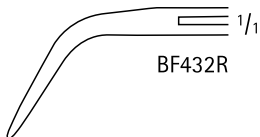

BF432R

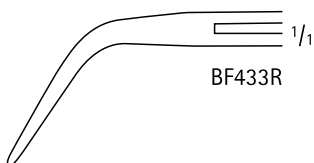

BF433R

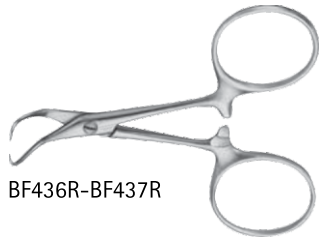

BF436R-BF437R

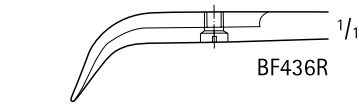

BF436R

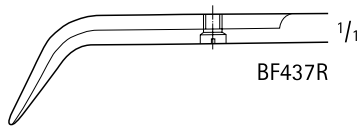

BF437R

BACKHAUS Towel Clamp, W/ Screw

Catalog Number	Length (in.)
BF436R	3 1/8
BF437R	4 1/8



BF444R

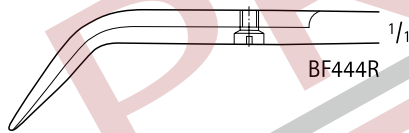

BF444R

**BACKHAUS-KOCHER Towel Clamp,
W/ Screw**

Catalog Number	Length (in.)
BF444R	5 1/4



BF448R

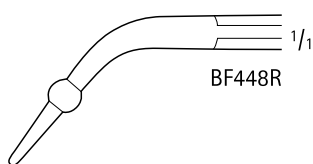

BF448R

ROEDER Towel Clamp, W/ Ball On Jaws

Catalog Number	Length (in.)
BF448R	5 1/4

Towel Clamp, Paper Drape

Catalog Number	Length (in.)
BF464R	5 1/2
BF460R	6

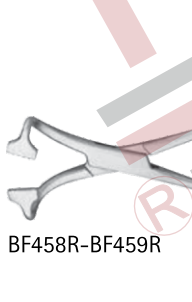
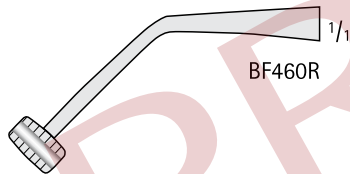
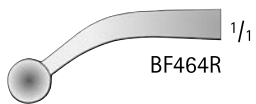

Non-Perforating Towel Forceps

Catalog Number	Length (in.)
BF458R	4
BF459R	5 1/2

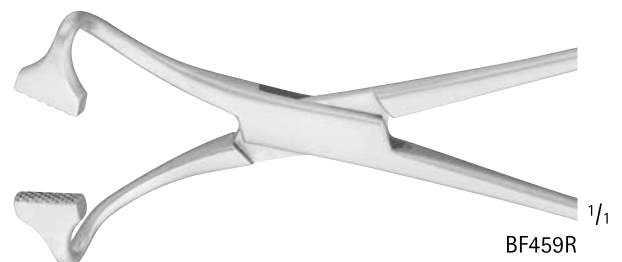
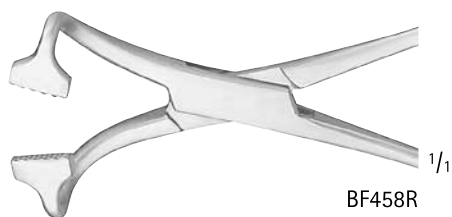

LORNA Non-Perforating Towel Clamp

Catalog Number	Length (in.)
BF461R	3 3/4
BF463R	5 1/8

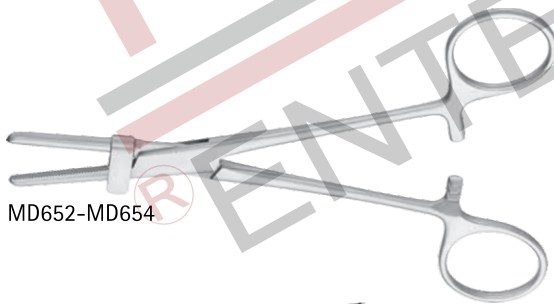
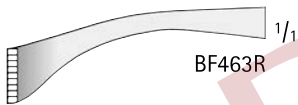

Tubing Clamp, W/ Guard

Catalog Number	Jaw	Length (in.)
MD652	SERR	6
MD653	SERR	7
MD654	SERR	7 7/8

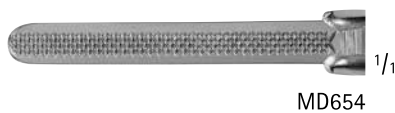
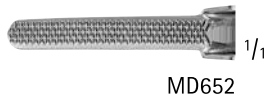

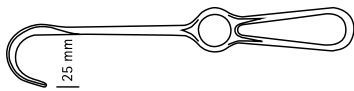

Dimensions for blade size of retractors
1st number = depth Example: 25 x 38 mm
2nd number = width



OL620R, MA185R, OL622R-OL624R, MD581

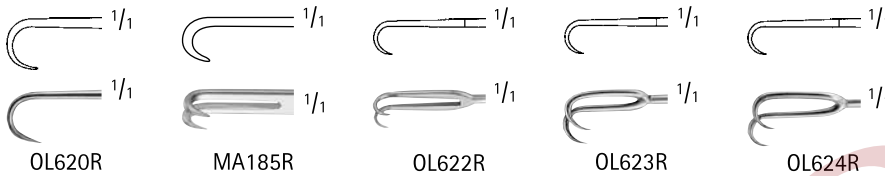

JOSEPH Skin Hook

Catalog Number	Tip	Prongs	Tip Size (mm)	Length (in.)
OL620R	SHARP	1	-	6 1/2
MA185R	SHARP	2	2	6 1/4
OL622R	SHARP	2	3	6 1/2
OL623R	SHARP	2	6	6 1/2
OL624R	SHARP	2	8	6 1/2
MD581	SHARP	2	10	6 1/2

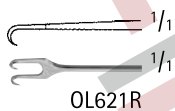

FREER Double Hook

Catalog Number	Tip	Tip Size (mm)	Length (in.)
OL621R	SHARP	2.0 x 3.2	6



GRAEFE Hook

Catalog Number	Tip	Length (in.)
OA332R	SHARP	5
OA333R	BLUNT	5

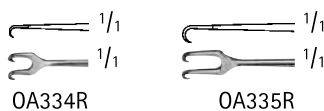

GUTHRIE Double Hook

Catalog Number	Tip	Length (in.)
OA334R	SHARP	5
OA335R	SHARP	5 1/8



OA336R-OA338R

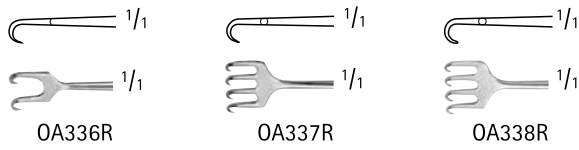

OL615R

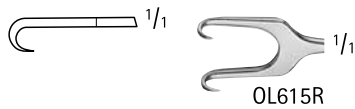

OA340R



OA351R

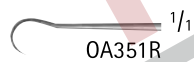

OL610R

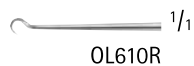

OL611R-OL612R



ROLLET Hook Retractor

Catalog Number	Tip	Blade End	Tip Size (mm)	Length (in.)
OA336R	SHARP	2 PRONGS	2.2 x 4.5	5 1/8
OA337R	SHARP	4 PRONGS	2.5 x 7.0	5 1/4
OA338R	BLUNT	4 PRONGS	2.2 x 7.0	5 1/4

MCINDOE Hook

Catalog Number	Tip	Blade End	Tip Size (mm)	Length (in.)
OL615R	SHARP	2 PRONGS	9	6

PAUL Tendon Hook

Catalog Number	Tip	Blade End	Tip Size (mm)	Length (in.)
OA340R	BLUNT	3 PRONGS	11 x 8	4 3/4

JAEGER Hook Retractor, Fine

Catalog Number	Tip	Length (in.)
OA351R	SHARP	5 1/4

KILNER Skin Hook

Catalog Number	Tip	Length (in.)
OL610R	SHARP	6 1/4

GILLIES Skin Hook

Catalog Number	Tip	Hook End	Length (in.)
OL611R	SHARP	SMALL	7
OL612R	SHARP	LARGE	7



BT075R



BT075R

BROM Vein Hook

Catalog Number	Length (in.)
BT075R	6 3/4



BT100R



BT100R

BERGMANN Hook

Catalog Number	Tip	Tip Size (mm)	Length (in.)
BT100R	SHARP	7	5 1/2



BT161R



BT161R

EMMET Fistula Hook

Catalog Number	Tip	Length (in.)
BT161R	SHARP	8 3/4



BT166R



BT166R

SIMON Fistula Hook

Catalog Number	Tip	Blade End	Length (in.)
BT166R	SHARP	1 PRONG	8 3/4
BT167R	SHARP	2 PRONGS	8 3/4



BT167R

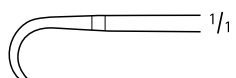

BT167R



BT006R-BT007R

**Baby SENN-MILLER Retractor,
Flat Handle**

Catalog Number	Tip	Blade End	Blade Size (mm)	Length (in.)
BT006R	SHARP	3 PRONGS	8 x 7 / 22 x 7	6 1/8
BT007R	BLUNT	3 PRONGS	8 x 7 / 22 x 7	6 1/8

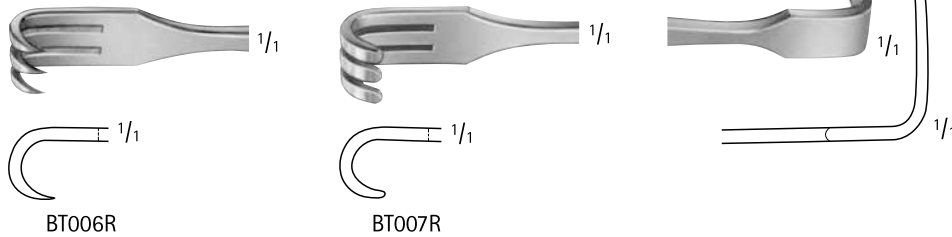

BT008R

SENN-MILLER Retractor

Catalog Number	Tip	Blade End	Blade Size (mm)	Length (in.)
BT008R	SHARP	3 PRONGS	8 x 7 / 18 x 5.5	6 1/2

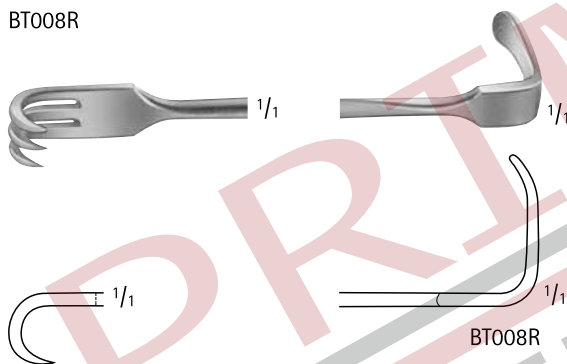

MG276R-MG277R

SENN Retractor, Round Tapered Handle

Catalog Number	Tip	Blade End	Blade Size (mm)	Length (in.)
MG276R	SHARP	3 PRONGS	9 x 10 / 22 x 7	6 1/4
MG277R	BLUNT	3 PRONGS	9 x 10 / 22 x 7	6 1/4

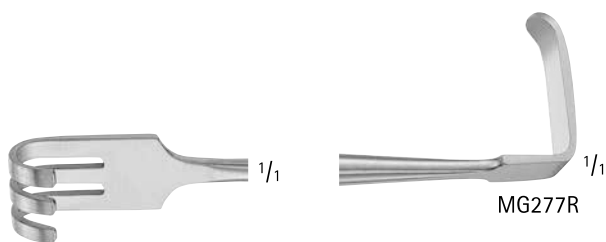
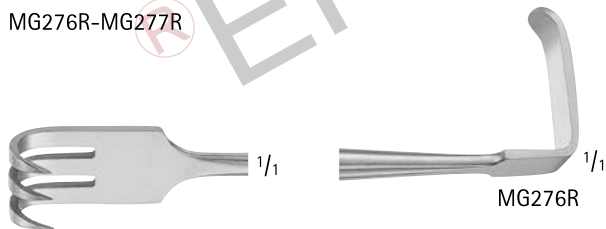

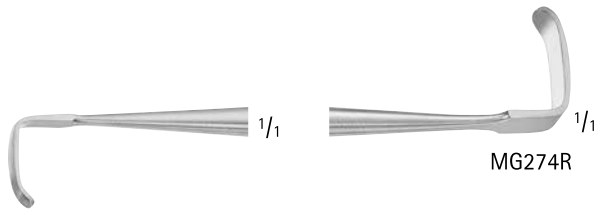
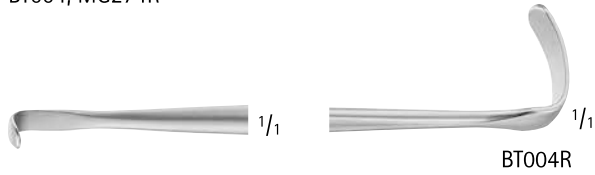

RAGNELL Retractor

Catalog Number	Blade Size (mm)	Length (in.)
BT004R	3 x 5 / 6.3 x 14	6
MG274R	3 x 11 / 5.4 x 17	6

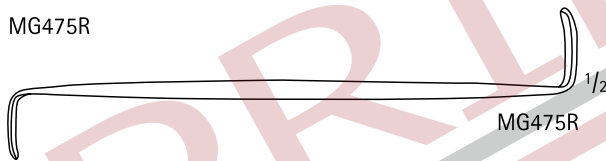

DAVIS Double Ended Retractor

Catalog Number	Blade Size (mm)	Length (in.)
MG475R	19 x 9 / 23 x 6.4	6



Double Ended Retractor

Catalog Number	Blade Size (mm)	Length (in.)
BT187R	20 x 15 / 20 x 19	8



GOELET Retractor

Catalog Number	Blade Size (mm)	Length (in.)
MD497	30 x 32 / 35 x 40	7 1/2



BT010R

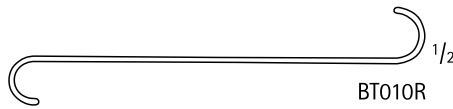

BT010R

LUER Retractor

Catalog Number	Blade Size (mm)	Length (in.)
BT010R	10 x 8 / 12 x 11	4 1/4



BT020R



BT020R

FARABEUF Retractor, 2/Set

Catalog Number	Blade Size (mm)	Length (in.)
BT020R	25 x 10 / 32 x 12 22 x 10 / 29 x 12	5
BT021R	23 x 16 / 28 x 16 19 x 16 / 24 x 16	6



BT021R



BT021R



MB984R

MAYO-COLLINS Retractor, 2/Set

Catalog Number	Blade Size (mm)	Length (in.)
MB984R	31 x 20 / 30 x 18 28 x 19 / 26 x 17	5 7/8



BT022R

COLLIN Retractor, 2/Set

Catalog Number	Blade Size (mm)	Length (in.)
BT022R	21 x 14 / 32 x 16 17 x 14 / 28 x 16	6



BT022R



BT012R

CRILE Retractor

Catalog Number	Blade Size (mm)	Length (in.)
BT012R	11 x 4 / 19 x 6	4 1/4



BT012R

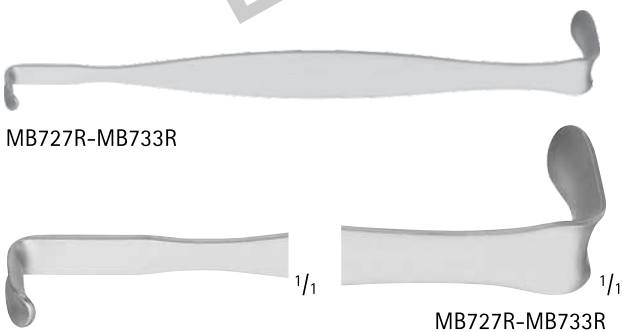

MB727R-MB733R

CRILE Retractor

Catalog Number	Size	Blade Size (mm)	Length (in.)
MB727R	1	3 x 11 / 6 x 21	4 1/4
MB728R	2	6 x 13 / 10 x 21	6 1/8
MB729R	3	16 x 25 / 17 x 35	6 1/4
MB730R	4	22 x 29 / 29 x 44	7
MB731R	5	29 x 41 / 35 x 51	7
MB732R	6	32 x 64 / 35 x 70	7 7/8
MB733R	7	41 x 76 / 51 x 79	8 7/8

MB727R-MB733R



BT011R

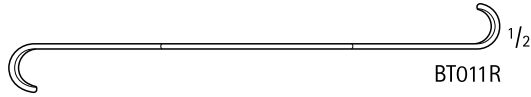

BT011R

ROSE Tracheal Retractor

Catalog Number	Blade Size (mm)	Length (in.)
BT011R	10 x 12 / 11 x 15	5 1/8



MG474R



MG474R

Children's Hospital Retractor

Catalog Number	Blade Size (mm)	Length (in.)
MG474R	11 x 22 / 14 x 35	4 1/2



BT025R



BT025R

PARKER Retractor, 2/Set

Catalog Number	Blade Size (mm)	Length (in.)
BT025R	22 x 15 / 22 x 15 18 x 15 / 18 x 15	5 1/4
BT026R	31 x 25 / 27 x 25 31 x 25 / 27 x 25	7



BT026R



BT034R-BT036R

ROUX Retractor

Catalog Number	Blade Size (mm)	Length (in.)
BT034R	20 x 22 / 25 x 29	6
BT035R	25 x 26 / 30 x 38	6 1/4
BT036R	28 x 29 / 33 x 44	6 3/4

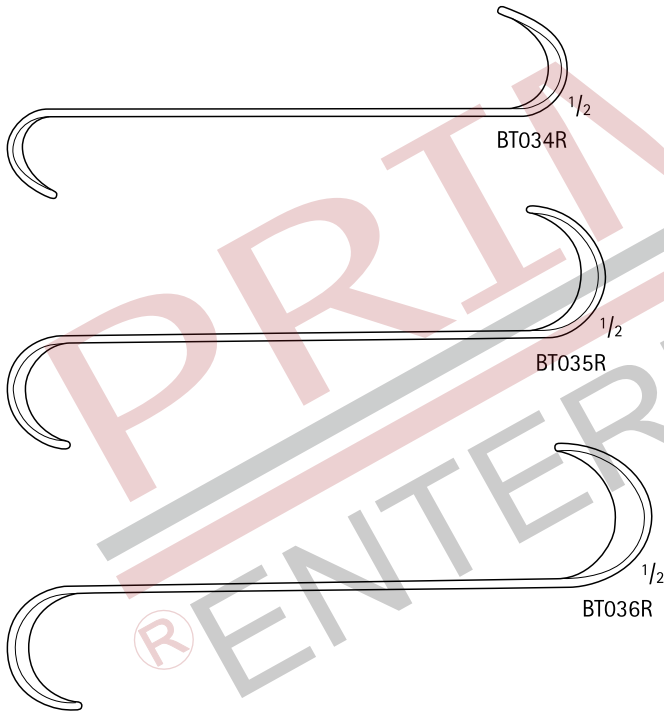



BT030R-BT033R

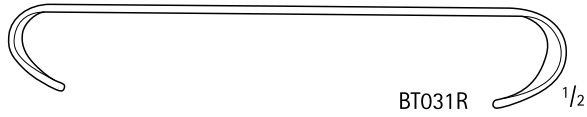

BT031R

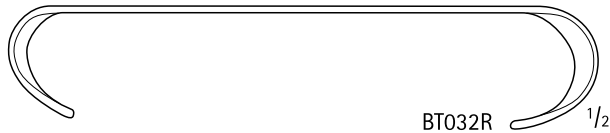

BT032R

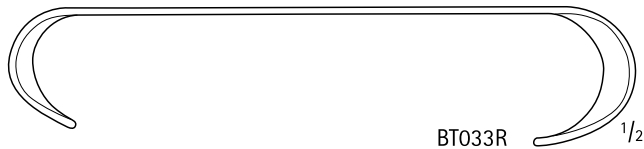

BT033R



MB584R-MB585R



MB584R

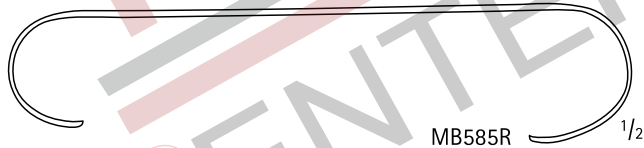

MB585R



BT029R



BT029R

ROUX Retractor

Catalog Number	Blade Size (mm)	Length (in.)
BT030R	COMPLETE SET BT031R-BT033R	-
BT031R	21 x 22 / 27 x 28	5 3/4
BT032R	26 x 26 / 32 x 26	6 1/8
BT033R	30 x 30 / 36 x 44	6 1/2

ROUX Retractor

Catalog Number	Blade Size (mm)	Length (in.)
MB584R	25 x 26 / 30 x 37	6 1/2
MB585R	28 x 28 / 29 x 40	6 1/2

ROUX Retractor, Long

Catalog Number	Blade Size (mm)	Length (in.)
BT029R	28 x 28 / 46 x 28	7 1/2



BT040R

MATHIEU Retractor, 2/Set

Catalog Number	Blade Size (mm)	Length (in.)
BT040R	42 x 13 / 41 x 13 45 x 25 / 40 x 25	7 7/8

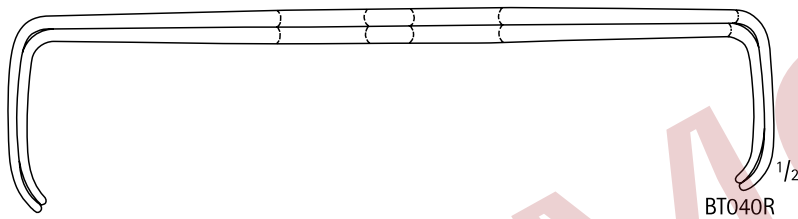

BT040R



BT041R

US Army Retractor, 2/Set

Catalog Number	Blade Size (mm)	Length (in.)
BT041R	26 x 15 / 22 x 15 43 x 15 / 39 x 15	8 3/4



BT041R



BT111R-BT119R

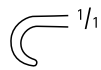
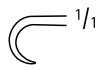

BT111R



BT116R



BT112R



BT117R



BT113R



BT118R



BT114R



BT119R



BT121R-BT129R

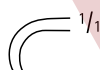

BT121R



BT126R



BT122R



BT127R



BT123R



BT128R



BT124R



BT129R

Hook, Small Curve

Catalog Number	Tip	Blade End	Blade Size (mm)	Length (in.)
BT111R	SHARP	1 PRONG	-	6 1/2
BT112R	SHARP	2 PRONGS	5.0 x 4.2	6 1/2
BT113R	SHARP	3 PRONGS	5.0 x 7.0	6 1/2
BT114R	SHARP	4 PRONGS	5.0 x 9.5	6 1/2
BT116R	BLUNT	1 PRONG	-	6 1/2
BT117R	BLUNT	2 PRONGS	4.5 x 4.2	6 1/2
BT118R	BLUNT	3 PRONGS	4.5 x 7.0	6 1/2
BT119R	BLUNT	4 PRONGS	4.5 x 9.0	6 1/2

Hook, Large Curve

Catalog Number	Tip	Blade End	Blade Size (mm)	Length (in.)
BT121R	SHARP	1 PRONG	-	6 1/2
BT122R	SHARP	2 PRONGS	7.5 x 7.5	6 1/2
BT123R	SHARP	3 PRONGS	7.5 x 10.0	6 1/2
BT124R	SHARP	4 PRONGS	7.5 x 14.0	6 1/2
BT126R	BLUNT	1 PRONG	-	6 1/2
BT127R	BLUNT	2 PRONGS	6.8 x 7.5	6 1/2
BT128R	BLUNT	3 PRONGS	6.8 x 10.0	6 1/2
BT129R	BLUNT	4 PRONGS	6.8 x 14.0	6 1/2

CRILE Hook and Dissector

Catalog Number	Length (in.)
MB060R	11 3/4



MB060R



MB060R



MB060R

KLAPP Tendon Hook

Catalog Number	Tip	Blade End	Blade Size (mm)	Length (in.)
BT172R	BLUNT	4 PRONGS	15 x 11	6 7/8



BT172R

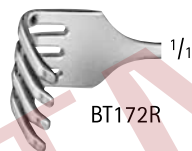
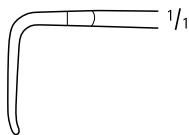

BT172R

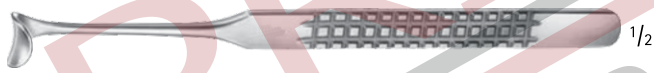

BT179R

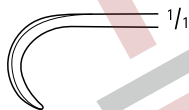

BT179R

Vein Retractor

Catalog Number	Blade Size (mm)	Length (in.)
BT179R	10 x 13	6 1/4



BT182R-BT183R



BT182R



BT183R

KOENIG Vein Retractor

Catalog Number	Blade Size (mm)	Length (in.)
BT182R	13 x 13	7
BT183R	12 x 16	7



BT193R-BT198R

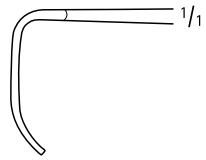

BT193R

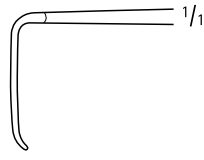

BT194R



BT195R

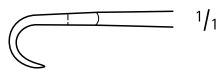

BT196R

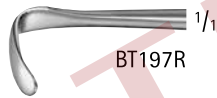
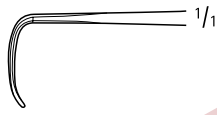

BT197R

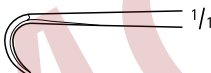

BT198R

MEYERDING Thumb Retractor

Catalog Number	Blade Size	Size (#)	Blade Size (mm)	Length (in.)
BT193R	A	1	18 x 7	7
BT194R	B	2	16 x 5	7
BT195R	C	3	7 x 4	7
BT196R	D	4	5 x 10	7
BT197R	E	5	11 x 4	7
BT198R	F	6	6 x 4	7



BT190R



BT190R



BT184R-BT185R



BT184R



BT185R

CUSHING-KOCHER Retractor

Catalog Number	Blade Size (mm)	Length (in.)
BT190R	10 x 10	6 7/8

CUSHING Vein Retractor

Catalog Number	Blade Size (mm)	Length (in.)
BT184R	10 x 13	8
BT185R	14 x 18	8

**CUSHING Vein Retractor
(continued)**

Catalog Number	Blade Size (mm)	Length (in.)
BT200R	14 x 11	9 3/4
BT202R	22 x 15	9 3/4



BT200R-BT202R



BT200R



BT202R

CUSHING Vein Retractor

Catalog Number	Blade Size (mm)	Length (in.)
MB912R	14	12 1/2
MB913R	14	14
MB914R	14	16



MB912R-MB914R



MB912R-MB914R

GIL VERNET Retractor, Malleable

Catalog Number	Blade Size (mm)	Length (in.)
MB766R	9	11 1/4
MB767R	11	11 1/4
MB768R	13	11 1/4
MB769R	18	11 1/4



MB766R-MB769R



MB766R-MB769R



BT221R

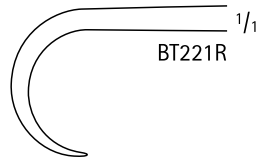

BT222R-BT230R

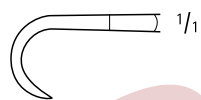

BT222R

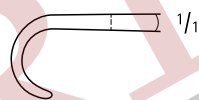

BT227R



BT223R



BT228R



BT224R



BT229R



BT225R



BT230R

VOLKMANN Retractor

Catalog Number	Tip	Blade End	Blade Size (mm)	Length (in.)
BT221R	SHARP	1 PRONG	8.5 x 8	8 3/4
BT222R	SHARP	2 PRONGS	9 x 8	8 7/8
BT223R	SHARP	3 PRONGS	9 x 13	8 7/8
BT224R	SHARP	4 PRONGS	9 x 19	8 7/8
BT225R	SHARP	6 PRONGS	9 x 29	8 7/8
BT227R	BLUNT	2 PRONGS	8.5 x 12	8 7/8
BT228R	BLUNT	3 PRONGS	8.5 x 13	8 7/8
BT229R	BLUNT	4 PRONGS	8.5 x 19	8 7/8
BT230R	BLUNT	6 PRONGS	8.5 x 29	8 7/8



BT240R-BT241R

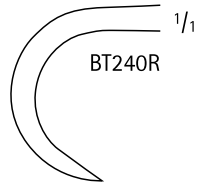

BT240R

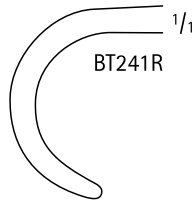

BT241R



BT242R-BT265R

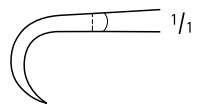

BT242R

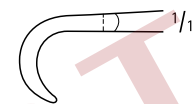

BT257R

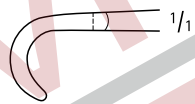

BT252R



BT243R



BT259R



BT253R



BT244R



BT260R



BT254R



BT246R



BT261R



BT256R



BT248R



BT265R



BT258R

VOLKMANN Retractor, Small

Catalog Number	Tip	Blade End	Blade Size (mm)	Length (in.)
BT240R	SHARP	1 PRONG	-	8 3/4
BT241R	BLUNT	1 PRONG	-	8 3/4
BT242R	SHARP	2 PRONGS	9 x 8	8 3/4
BT243R	SHARP	3 PRONGS	9 x 13	8 3/4
BT244R	SHARP	4 PRONGS	9 x 19	8 3/4
BT246R	SHARP	6 PRONGS	9 x 29	8 3/4
BT248R	SHARP	8 PRONGS	9 x 40	8 3/4
BT257R	SEMI-S	2 PRONGS	8.5 x 8	8 3/4
BT259R	SEMI-S	3 PRONGS	8.5 x 13	8 3/4
BT260R	SEMI-S	4 PRONGS	8.5 x 19	8 3/4
BT261R	SEMI-S	6 PRONGS	8.5 x 29	8 3/4
BT265R	SEMI-S	8 PRONGS	8.5 x 40	8 3/4
BT252R	BLUNT	2 PRONGS	8 x 8	8 3/4
BT253R	BLUNT	3 PRONGS	8 x 13	8 3/4
BT254R	BLUNT	4 PRONGS	8 x 19	8 3/4
BT256R	BLUNT	6 PRONGS	8 x 29	8 3/4
BT258R	BLUNT	8 PRONGS	8 x 40	8 3/4

VOLKMANN Retractor, US Version

Catalog Number	Tip	Blade End	Blade Size (mm)	Length (in.)
MG260R	SHARP	2 PRONGS	20 x 11	8 3/4
MG261R	SHARP	3 PRONGS	20 x 18	8 3/4
MG262R	SHARP	4 PRONGS	20 x 26	8 3/4
MG264R	SHARP	6 PRONGS	20 x 40	8 3/4
MG265R	BLUNT	2 PRONGS	20 x 11	8 3/4
MG266R	BLUNT	3 PRONGS	20 x 18	8 3/4
MG267R	BLUNT	4 PRONGS	20 x 26	8 3/4
MG269R	BLUNT	6 PRONGS	20 x 40	8 3/4



MG260R-MG264R



MG265R-MG269R



MG260R



MG265R



MG261R



MG266R

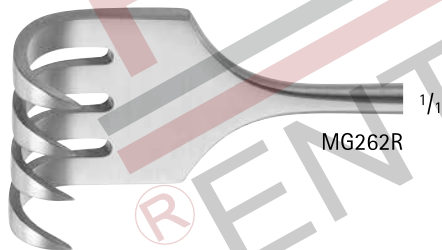

MG262R

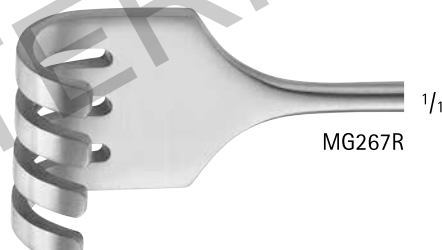

MG267R



MG264R



MG269R



BT262R-BT276R

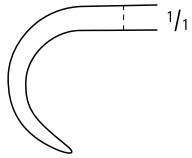

BT262R



BT263R



BT264R



BT266R

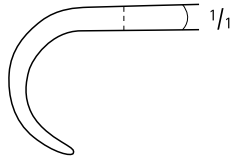

BT272R



BT273R



BT274R

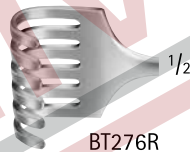

BT276R

KOCHER Retractor, Large

Catalog Number	Tip	Blade End	Blade Size (mm)	Length (in.)
BT262R	SEMI-S	2 PRONGS	16 x 9	8 3/4
BT263R	SEMI-S	3 PRONGS	16 x 14	8 3/4
BT264R	SEMI-S	4 PRONGS	16 x 20	8 3/4
BT266R	SEMI-S	6 PRONGS	16 x 30	8 3/4
BT272R	BLUNT	2 PRONGS	15.5 x 9	8 3/4
BT273R	BLUNT	3 PRONGS	15.5 x 14	8 3/4
BT274R	BLUNT	4 PRONGS	15.5 x 20	8 3/4
BT276R	BLUNT	6 PRONGS	15.5 x 30	8 3/4



BT278R-BT279R

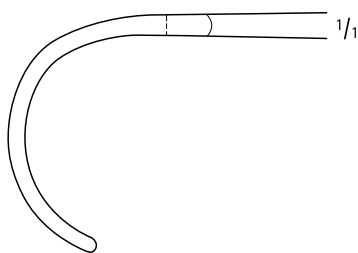

BT279R



BT278R

KOERTE Retractor

Catalog Number	Tip	Blade End	Blade Size (mm)	Length (in.)
BT279R	SEMI-S	8 PRONGS	26 x 40	9 1/2
BT278R	BLUNT	8 PRONGS	26 x 40	9 1/2

ISRAEL Retractor, T-Handle

Catalog Number	Tip	Blade End	Blade Size (mm)	Length (in.)
MG284R	BLUNT	4 PRONGS	46 x 40	7 1/2



MG284R



MG284R

MURPHY Retractor

Catalog Number	Tip	Blade End	Length (in.)
BT293R	SHARP	3 PRONGS	7 3/4
BT294R	SHARP	4 PRONGS	7 3/4
BT296R	BLUNT	4 PRONGS	7 3/4

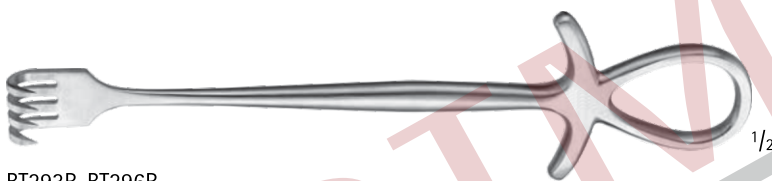

BT293R-BT296R



BT293R

BT296R



BT294R

KOERTE-WAGNER Retractor

Catalog Number	Tip	Blade End	Blade Size (mm)	Length (in.)
BT290R	SEMI-S	8 PRONGS	28 x 40	11



BT290R

BT290R



BT111R-BT119R

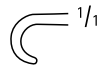
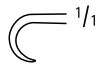

BT111R



BT116R



BT112R



BT117R



BT113R



BT118R



BT114R



BT119R



BT121R-BT129R



BT121R



BT126R



BT122R



BT127R



BT123R



BT128R



BT124R



BT129R

Hook, Small Curve

Catalog Number	Tip	Blade End	Blade Size (mm)	Length (in.)
BT111R	SHARP	1 PRONG	-	6 1/2
BT112R	SHARP	2 PRONGS	5.0 x 4.2	6 1/2
BT113R	SHARP	3 PRONGS	5.0 x 7.0	6 1/2
BT114R	SHARP	4 PRONGS	5.0 x 9.5	6 1/2
BT116R	BLUNT	1 PRONG	-	6 1/2
BT117R	BLUNT	2 PRONGS	4.5 x 4.2	6 1/2
BT118R	BLUNT	3 PRONGS	4.5 x 7.0	6 1/2
BT119R	BLUNT	4 PRONGS	4.5 x 9.0	6 1/2

Hook, Large Curve

Catalog Number	Tip	Blade End	Blade Size (mm)	Length (in.)
BT121R	SHARP	1 PRONG	-	6 1/2
BT122R	SHARP	2 PRONGS	7.5 x 7.5	6 1/2
BT123R	SHARP	3 PRONGS	7.5 x 10.0	6 1/2
BT124R	SHARP	4 PRONGS	7.5 x 14.0	6 1/2
BT126R	BLUNT	1 PRONG	-	6 1/2
BT127R	BLUNT	2 PRONGS	6.8 x 7.5	6 1/2
BT128R	BLUNT	3 PRONGS	6.8 x 10.0	6 1/2
BT129R	BLUNT	4 PRONGS	6.8 x 14.0	6 1/2



BT354R-BT365R

KOCHER-LANGENBECK Retractor

Catalog Number	Blade Size (mm)	Length (in.)
BT354R	25 x 6	8 1/2
BT356R	35 x 8	8 1/2
BT357R	35 x 11	8 1/2
BT358R	35 x 15	8 1/2
BT359R	41 x 11	8 1/2
BT361R	55 x 11	8 1/2
BT363R	70 x 14	8 1/2
BT364R	80 x 12	8 1/2
BT365R	80 x 16	8 1/2

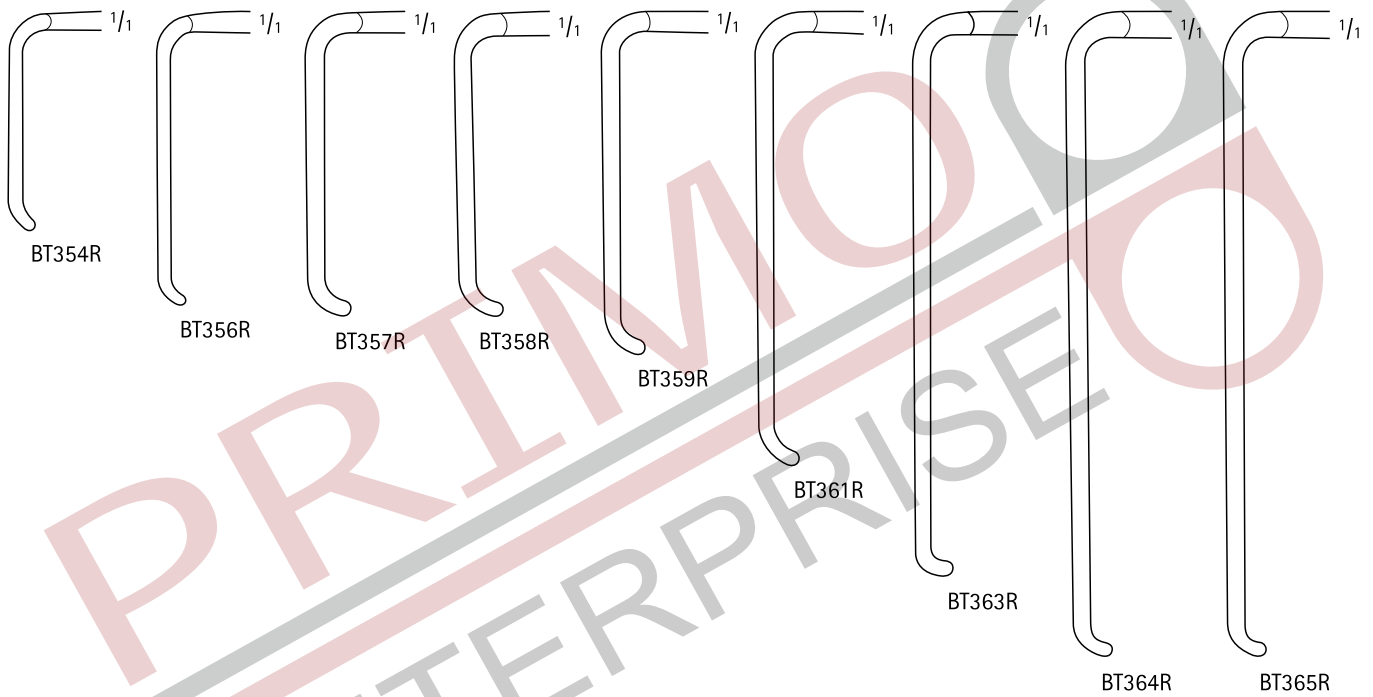

MB785R

LAHEY Goiter Retractor

Catalog Number	Blade Size (mm)	Length (in.)
MB785R	24 x 8	7 7/8



MB785R



MB748R

MCBURNEY Thyroid Retractor

Catalog Number	Blade Size (mm)	Length (in.)
MB748R	20 x 10	7 1/2



MB748R



BT404R-BT406R

MIDDELDORPF Retractor

Catalog Number	Blade Size (mm)	Length (in.)
BT404R	15 x 15	8 3/4
BT405R	20 x 22	8 1/2
BT406R	28 x 28	9 1/4

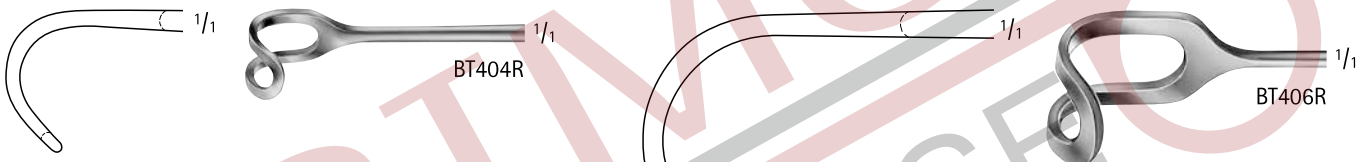

BT404R

BT406R

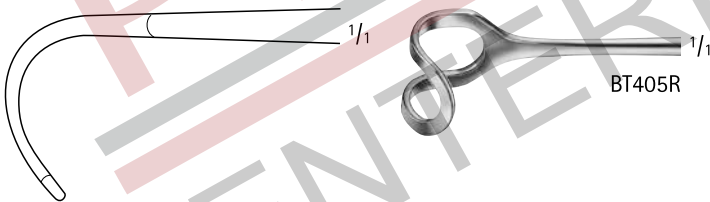

BT405R



BT408R

GREENE Retractor

Catalog Number	Blade Size (mm)	Length (in.)
BT408R	28 x 22	8 7/8

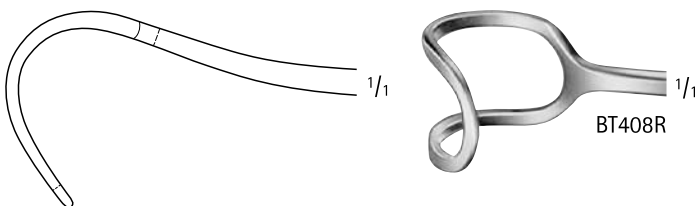

BT408R